



UM18-21712D212

UM18

ULTRASONIC SENSORS

**SICK**  
Sensor Intelligence.



### Ordering information

Type	Part no.
UM18-21712D212	6066167

Other models and accessories → [www.sick.com/UM18](http://www.sick.com/UM18)



### Detailed technical data

#### Mechanics/electronics

<b>Supply voltage <math>V_s</math></b>	DC 10 V ... 30 V <sup>1)</sup>
<b>Power consumption</b>	$\leq 1.2$ W <sup>2)</sup>
<b>Initialization time</b>	< 300 ms
<b>Design</b>	Cylindrical
<b>Housing material</b>	Metal (nickel-plated brass, ultrasonic transducer: polyurethane foam, glass epoxy resin)
<b>Thread size</b>	M18 x 1
<b>Connection type</b>	Male connector, M12, 5-pin
<b>Indication</b>	2 x LED
<b>Weight</b>	30 g
<b>Sending axis</b>	Angled
<b>Dimensions (W x H x D)</b>	18 mm x 18 mm x 68.7 mm
<b>Enclosure rating</b>	IP65 / IP67
<b>Protection class</b>	III

<sup>1)</sup> Limit values, reverse-polarity protected Operation in short-circuit protected network: max. 8 A, class 2.

<sup>2)</sup> Without load.

#### Performance

<b>Operating range, limiting range</b>	20 mm ... 150 mm, 250 mm
<b>Target</b>	Natural objects
<b>Resolution</b>	$\geq 0.069$ mm
<b>Repeatability</b>	$\pm 0.15$ % <sup>1)</sup>

<sup>1)</sup> In relation to the current measured value, minimum value  $\geq$  resolution.

<sup>2)</sup> Referring to current measurement value.

<sup>3)</sup> Temperature compensation can be switched off, without temperature compensation: 0.17 % / K.

<sup>4)</sup> Subsequent smoothing of the analog output, depending on the application, may increase the response time by up to 200 %.

<b>Accuracy</b>	$\pm 1 \%$ <sup>2) 3)</sup>
<b>Temperature compensation</b>	✓
<b>Response time</b>	32 ms <sup>4)</sup>
<b>Switching frequency</b>	25 Hz
<b>Output time</b>	8 ms
<b>Ultrasonic frequency (typical)</b>	380 kHz
<b>Additional function</b>	Adjustable operating modes: Switching point (DtO) / Switching window/Background (ObSB), teach-in of digital output, invertible digital output, teach-in of analog output, Invertable analog output, multifunctional input: external teach / synchronization / multiplexing, synchronization of up to 20 sensors, multiplexing: no cross talk of up to 20 sensors, reset to factory default

<sup>1)</sup> In relation to the current measured value, minimum value  $\geq$  resolution.

<sup>2)</sup> Referring to current measurement value.

<sup>3)</sup> Temperature compensation can be switched off, without temperature compensation: 0.17 % / K.

<sup>4)</sup> Subsequent smoothing of the analog output, depending on the application, may increase the response time by up to 200 %.

## Interfaces

<b>IO-Link</b>	✓, IO-Link V1.1
Function	Process data, parameterization, diagnosis, data storage
<b>Digital output</b>	
Number	1 <sup>1)</sup>
Type	Push-pull: PNP/NPN
Maximum output current $I_A$	$\leq 100$ mA
<b>Analog output</b>	
Number	1
Type	Voltage output
Voltage	0 V ... 10 V, $\geq 100,000 \Omega$
Resolution	12 bit
<b>Multifunctional input (MF)</b>	1 x MF
<b>Hysteresis</b>	2 mm

<sup>1)</sup> Push-pull: PNP/NPN HIGH =  $U_V - (< 3 \text{ V})$  / LOW  $< 3 \text{ V}$ .

## Ambient data

<b>Ambient temperature operation</b>	-25 °C ... +70 °C
<b>Ambient storage temperature</b>	-40 °C ... +85 °C

## Classifications

<b>ECl@ss 5.0</b>	27270804
<b>ECl@ss 5.1.4</b>	27270804
<b>ECl@ss 6.0</b>	27270804
<b>ECl@ss 6.2</b>	27270804
<b>ECl@ss 7.0</b>	27270804
<b>ECl@ss 8.0</b>	27270804
<b>ECl@ss 8.1</b>	27270804
<b>ECl@ss 9.0</b>	27270804
<b>ECl@ss 10.0</b>	27270804

<b>ECl@ss 11.0</b>	27270804
<b>ETIM 5.0</b>	EC001846
<b>ETIM 6.0</b>	EC001846
<b>ETIM 7.0</b>	EC001846
<b>UNSPSC 16.0901</b>	41111960

### Dimensional drawing (Dimensions in mm (inch))

UM18-2xxxxx2

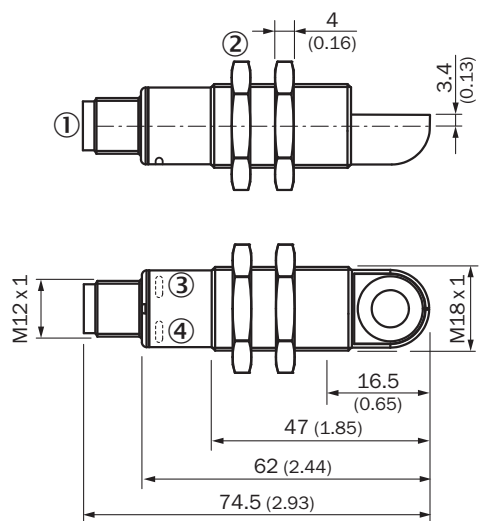

- ① Connection
- ② Fixing nuts, width 24 mm
- ③ Status display for supply voltage active (green)
- ④ Status indicator switching/analog output (orange)

### Connection type

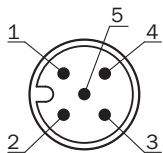

## Connection diagram

UM18-21xxxCxxx\_Dxxx, male connector M12, 5-pin

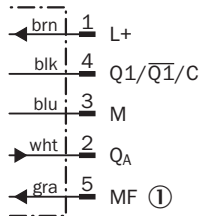

① Multifunctional input/synchronization and multiplex operation/communication Connect+

## Detection area

UM1x-x17

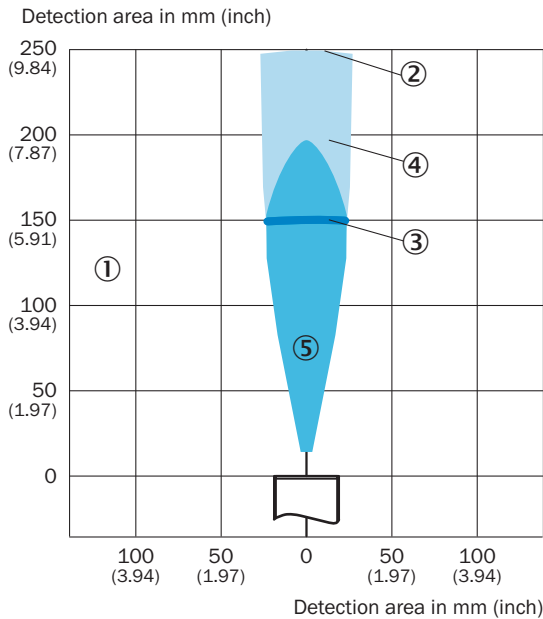

① Detection range dependent on reflection properties, size, and alignment of the object

② Limiting range

③ Operating range



④ Example object: aligned plate 500 mm x 500 mm

⑤ Example object: cylindrical bar with a diameter of 10 mm

## Recommended accessories

Other models and accessories → [www.sick.com/UM18](http://www.sick.com/UM18)

	Brief description	Type	Part no.
Mounting brackets and plates			
	Mounting plate for M18 sensors, steel, zinc coated, without mounting hardware	BEF-WG-M18	5321870

	Brief description	Type	Part no.
<b>Deflector mirrors</b>			
	90° sound deflection plate for UM18-1xxx and UM18-2xxx, stainless steel, for straight versions	USP-UM18	5323658
<b>Connection modules</b>			
	IO-Link V1.1 Class A port, USB2.0 port, optional external power supply 24V / 1A	IOLA2US-01101 (SiLink2 Master)	1061790
<b>Plug connectors and cables</b>			
	Head A: female connector, M12, 5-pin, straight, A-coded Head B: Flying leads Cable: Sensor/actuator cable, PVC, unshielded, 2 m	YF2A15-020VB5XLEAX	2096239

### Recommended services

Additional services → [www.sick.com/UM18](http://www.sick.com/UM18)

	Type	Part no.
<b>Warranty extensions</b>		
<ul style="list-style-type: none"> <li>• <b>Product area:</b> Identification solutions, machine vision, Distance sensors, Detection and ranging solutions</li> <li>• <b>Range of services:</b> The services correspond to the scope of the statutory manufacturer warranty (SICK general terms and conditions of purchase)</li> <li>• <b>Duration:</b> Five-year warranty from delivery date.</li> </ul>	Extended warranty for a total of five years from delivery date	1680671

## SICK AT A GLANCE

SICK is one of the leading manufacturers of intelligent sensors and sensor solutions for industrial applications. A unique range of products and services creates the perfect basis for controlling processes securely and efficiently, protecting individuals from accidents and preventing damage to the environment.

We have extensive experience in a wide range of industries and understand their processes and requirements. With intelligent sensors, we can deliver exactly what our customers need. In application centers in Europe, Asia and North America, system solutions are tested and optimized in accordance with customer specifications. All this makes us a reliable supplier and development partner.

Comprehensive services complete our offering: SICK LifeTime Services provide support throughout the machine life cycle and ensure safety and productivity.

For us, that is “Sensor Intelligence.”

## WORLDWIDE PRESENCE:

Contacts and other locations –[www.sick.com](http://www.sick.com)