



UM18-218166101

UM18

ULTRASONIC SENSORS

SICK
Sensor Intelligence.



Ordering information

Type	Part no.
UM18-218166101	6072883

Other models and accessories → www.sick.com/UM18



Detailed technical data

Mechanics/electronics

Supply voltage V_s	DC 10 V ... 30 V ¹⁾
Power consumption	≤ 1.2 W ²⁾
Initialization time	< 300 ms
Design	Cylindrical
Housing material	Plastic (PBT, ultrasonic transducer: polyurethane foam, glass epoxy resin)
Thread size	M18 x 1
Connection type	Male connector, M12, 4-pin
Indication	2 x LED
Weight	15 g
Sending axis	Straight
Dimensions (W x H x D)	18 mm x 18 mm x 52.7 mm
Enclosure rating	IP65 / IP67
Protection class	III

¹⁾ Limit values, reverse-polarity protected Operation in short-circuit protected network: max. 8 A, class 2.

²⁾ Without load.

Performance

Operating range, limiting range	120 mm ... 1,000 mm, 1,300 mm
Target	Natural objects
Resolution	≥ 0.2 mm
Repeatability	± 0.15 % ¹⁾
Accuracy	± 1 % ²⁾
Response time	80 ms ³⁾
Output time	20 ms
Ultrasonic frequency (typical)	200 kHz
Detection area (typical)	See diagrams

¹⁾ In relation to the current measured value, minimum value ≥ resolution.

²⁾ Referring to current measurement value.

³⁾ Subsequent smoothing of the analog output, depending on the application, may increase the response time by up to 200 %.

Additional function	Teach-in of analog output, Invertable analog output, reset to factory default
----------------------------	---

- 1) In relation to the current measured value, minimum value \geq resolution.
 2) Referring to current measurement value.
 3) Subsequent smoothing of the analog output, depending on the application, may increase the response time by up to 200 %.

Interfaces

Analog output	
Number	1
Type	Current output
Current	4 mA ... 20 mA, $\leq 500 \Omega$ ¹⁾
Resolution	12 bit

¹⁾ For 4 mA ... 20 mA and $V_S \leq 20$ V max. load $\leq 100 \Omega$.

Ambient data

Ambient temperature operation	-25 °C ... +70 °C
Ambient storage temperature	-40 °C ... +85 °C
Temperature drift	0.17 % / K ¹⁾

¹⁾ Referring to current measurement value.

Classifications

ECl@ss 5.0	27270804
ECl@ss 5.1.4	27270804
ECl@ss 6.0	27270804
ECl@ss 6.2	27270804
ECl@ss 7.0	27270804
ECl@ss 8.0	27270804
ECl@ss 8.1	27270804
ECl@ss 9.0	27270804
ECl@ss 10.0	27270804
ECl@ss 11.0	27270804
ETIM 5.0	EC001846
ETIM 6.0	EC001846
ETIM 7.0	EC001846
UNSPSC 16.0901	41111960

Dimensional drawing (Dimensions in mm (inch))

UM18-2xxxxx1

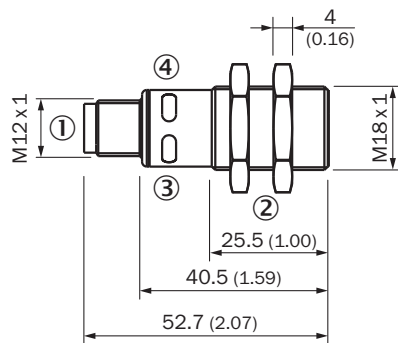

- ① Connection
- ② Fixing nuts, width 24 mm
- ③ Status display for supply voltage active (green)
- ④ Status indicator switching/analog output (orange)

Connection type

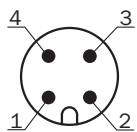

Connection diagram

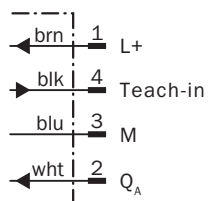

Detection area

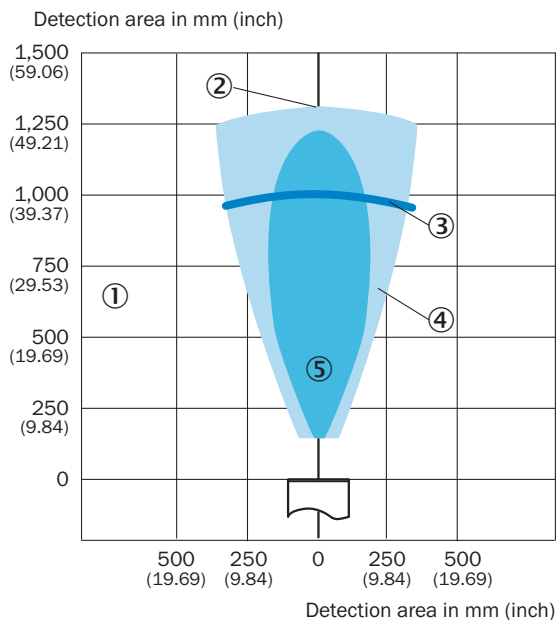

UM18-218



- ① Detection range dependent on reflection properties, size, and alignment of the object
- ② Limiting range
- ③ Operating range
- ④ Example object: aligned plate 500 mm x 500 mm
- ⑤ Example object: pipe with 27 mm diameter

Recommended accessories

Other models and accessories → www.sick.com/UM18

	Brief description	Type	Part no.
Mounting brackets and plates			
	Mounting plate for M18 sensors, steel, zinc coated, without mounting hardware	BEF-WG-M18	5321870
Deflector mirrors			
	90° sound deflection plate for UM18-1xxxx and UM18-2xxxx, stainless steel, for straight versions	USP-UM18	5323658
Plug connectors and cables			
	Head A: female connector, M12, 5-pin, straight, A-coded Head B: Flying leads Cable: Sensor/actuator cable, PVC, unshielded, 2 m	YF2A15-020VB5XLEAX	2096239

Recommended services

Additional services → www.sick.com/UM18

	Type	Part no.
Warranty extensions		
<ul style="list-style-type: none">• Product area: Identification solutions, machine vision, Distance sensors, Detection and ranging solutions• Range of services: The services correspond to the scope of the statutory manufacturer warranty (SICK general terms and conditions of purchase)• Duration: Five-year warranty from delivery date.	Extended warranty for a total of five years from delivery date	1680671

SICK AT A GLANCE

SICK is one of the leading manufacturers of intelligent sensors and sensor solutions for industrial applications. A unique range of products and services creates the perfect basis for controlling processes securely and efficiently, protecting individuals from accidents and preventing damage to the environment.

We have extensive experience in a wide range of industries and understand their processes and requirements. With intelligent sensors, we can deliver exactly what our customers need. In application centers in Europe, Asia and North America, system solutions are tested and optimized in accordance with customer specifications. All this makes us a reliable supplier and development partner.

Comprehensive services complete our offering: SICK LifeTime Services provide support throughout the machine life cycle and ensure safety and productivity.

For us, that is “Sensor Intelligence.”

WORLDWIDE PRESENCE:

Contacts and other locations –www.sick.com