

UM18-218167102

UM18

ULTRASONIC SENSORS

**SICK**  
Sensor Intelligence.

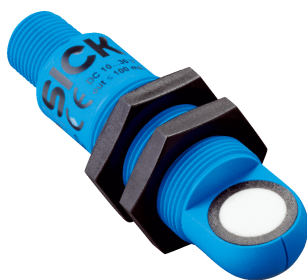

### Ordering information

Type	Part no.
UM18-218167102	6072886

Other models and accessories → [www.sick.com/UM18](http://www.sick.com/UM18)



### Detailed technical data

#### Mechanics/electronics

<b>Supply voltage <math>V_s</math></b>	DC 15 V ... 30 V <sup>1)</sup>
<b>Power consumption</b>	≤ 1.2 W <sup>2)</sup>
<b>Initialization time</b>	< 300 ms
<b>Design</b>	Cylindrical
<b>Housing material</b>	Plastic (PBT, ultrasonic transducer: polyurethane foam, glass epoxy resin)
<b>Thread size</b>	M18 x 1
<b>Connection type</b>	Male connector, M12, 4-pin
<b>Indication</b>	2 x LED
<b>Weight</b>	20 g
<b>Sending axis</b>	Angled
<b>Dimensions (W x H x D)</b>	18 mm x 18 mm x 68.7 mm
<b>Enclosure rating</b>	IP65 / IP67
<b>Protection class</b>	III

<sup>1)</sup> Limit values, reverse-polarity protected Operation in short-circuit protected network: max. 8 A, class 2.

<sup>2)</sup> Without load.

#### Performance

<b>Operating range, limiting range</b>	120 mm ... 1,000 mm, 1,300 mm
<b>Target</b>	Natural objects
<b>Resolution</b>	≥ 0.2 mm
<b>Repeatability</b>	± 0.15 % <sup>1)</sup>
<b>Accuracy</b>	± 1 % <sup>2)</sup>
<b>Response time</b>	80 ms <sup>3)</sup>
<b>Output time</b>	20 ms
<b>Ultrasonic frequency (typical)</b>	200 kHz
<b>Detection area (typical)</b>	See diagrams

<sup>1)</sup> In relation to the current measured value, minimum value ≥ resolution.

<sup>2)</sup> Referring to current measurement value.

<sup>3)</sup> Subsequent smoothing of the analog output, depending on the application, may increase the response time by up to 200 %.

<b>Additional function</b>	Teach-in of analog output, Invertable analog output, reset to factory default
----------------------------	---

- 1) In relation to the current measured value, minimum value  $\geq$  resolution.  
 2) Referring to current measurement value.  
 3) Subsequent smoothing of the analog output, depending on the application, may increase the response time by up to 200 %.

## Interfaces

<b>Analog output</b>	
Number	1
Type	Voltage output
Voltage	0 V ... 10 V, $\geq 100,000 \Omega$
Resolution	12 bit

## Ambient data

<b>Ambient temperature operation</b>	-25 °C ... +70 °C
<b>Ambient storage temperature</b>	-40 °C ... +85 °C
<b>Temperature drift</b>	0.17 % / K <sup>1)</sup>

- 1) Referring to current measurement value.

## Classifications

<b>ECl@ss 5.0</b>	27270804
<b>ECl@ss 5.1.4</b>	27270804
<b>ECl@ss 6.0</b>	27270804
<b>ECl@ss 6.2</b>	27270804
<b>ECl@ss 7.0</b>	27270804
<b>ECl@ss 8.0</b>	27270804
<b>ECl@ss 8.1</b>	27270804
<b>ECl@ss 9.0</b>	27270804
<b>ECl@ss 10.0</b>	27270804
<b>ECl@ss 11.0</b>	27270804
<b>ETIM 5.0</b>	EC001846
<b>ETIM 6.0</b>	EC001846
<b>ETIM 7.0</b>	EC001846
<b>UNSPSC 16.0901</b>	41111960

### Dimensional drawing (Dimensions in mm (inch))

UM18-2xxxxx2

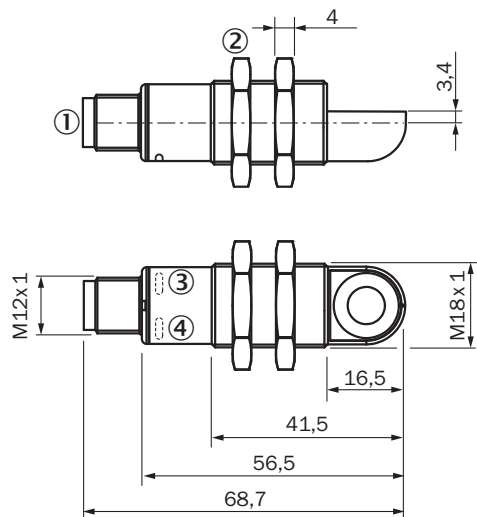

- ① Connection
- ② Fixing nuts, width 24 mm
- ③ Status display for supply voltage active (green)
- ④ Status indicator switching/analog output (orange)

### Connection type

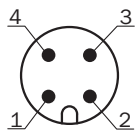

### Connection diagram

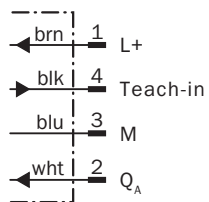

## Detection area

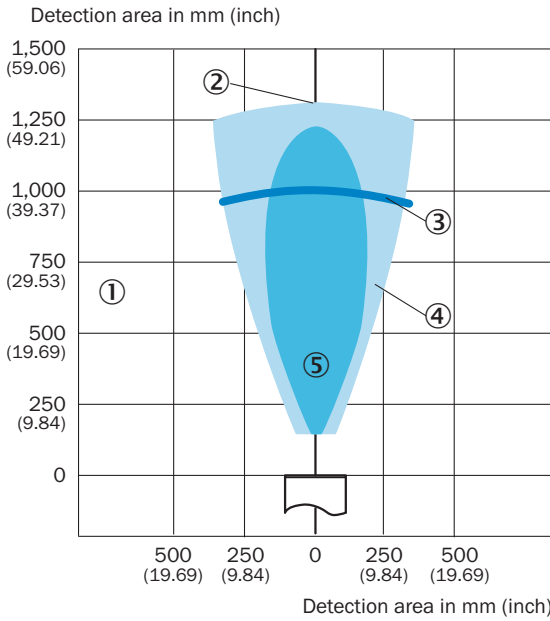

UM18-218



- ① Detection range dependent on reflection properties, size, and alignment of the object
- ② Limiting range
- ③ Operating range
- ④ Example object: aligned plate 500 mm x 500 mm
- ⑤ Example object: pipe with 27 mm diameter

## Recommended accessories

Other models and accessories → [www.sick.com/UM18](http://www.sick.com/UM18)

	Brief description	Type	Part no.
<b>Mounting brackets and plates</b>			
	Mounting plate for M18 sensors, steel, zinc coated, without mounting hardware	BEF-WG-M18	5321870
<b>Deflector mirrors</b>			
	90° sound deflection plate for UM18-1xxxx and UM18-2xxxx, stainless steel, for straight versions	USP-UM18	5323658
<b>Plug connectors and cables</b>			
	Head A: female connector, M12, 5-pin, straight, A-coded Head B: Flying leads Cable: Sensor/actuator cable, PVC, unshielded, 2 m	YF2A15-020VB5XLEAX	2096239

### Recommended services

Additional services → [www.sick.com/UM18](http://www.sick.com/UM18)

	Type	Part no.
Warranty extensions		
<ul style="list-style-type: none"><li>• <b>Product area:</b> Identification solutions, machine vision, Distance sensors, Detection and ranging solutions</li><li>• <b>Range of services:</b> The services correspond to the scope of the statutory manufacturer warranty (SICK general terms and conditions of purchase)</li><li>• <b>Duration:</b> Five-year warranty from delivery date.</li></ul>	Extended warranty for a total of five years from delivery date	1680671

## SICK AT A GLANCE

SICK is one of the leading manufacturers of intelligent sensors and sensor solutions for industrial applications. A unique range of products and services creates the perfect basis for controlling processes securely and efficiently, protecting individuals from accidents and preventing damage to the environment.

We have extensive experience in a wide range of industries and understand their processes and requirements. With intelligent sensors, we can deliver exactly what our customers need. In application centers in Europe, Asia and North America, system solutions are tested and optimized in accordance with customer specifications. All this makes us a reliable supplier and development partner.

Comprehensive services complete our offering: SICK LifeTime Services provide support throughout the machine life cycle and ensure safety and productivity.

For us, that is “Sensor Intelligence.”

## WORLDWIDE PRESENCE:

Contacts and other locations –[www.sick.com](http://www.sick.com)