



SLG25S-080FBKA1K01

FlexChain

SWITCHING AUTOMATION LIGHT GRIDS

SICK
Sensor Intelligence.



Ordering information

Type	Part no.
SLG25S-080FBKA1K01	1222991

Only in conjunction with FlexChain host

[1091608](https://www.sick.com/1091608) | FC1A-AZ2A1A: Standard I/O

[1091609](https://www.sick.com/1091609) | FC1A-BZ2A1A: Advanced I/O

[1091610](https://www.sick.com/1091610) | FC1A-CZ2A1A: RS-485

[1091611](https://www.sick.com/1091611) | FC1A-DZ2A1A: CANopen

Other models and accessories → www.sick.com/FlexChain



Detailed technical data

Features

Device version	FlexChain Guest
Sensor principle	Sender/receiver Light grid system
Minimum detectable object (MDO)	30 mm
Beam separation	25 mm
Optical light exit	Flat
Number of beams	32
Detection height	800 mm

Mechanics/electronics

Light source	Infrared light
Wave length	850 nm
Supply voltage V_s	Via FlexChain (host)
Output load capacitive	100 nF
Output load inductive	1 H
Initialization time	1 s
Dimensions (W x H x D)	11.8 mm x 799.2 mm x 24.1 mm
Connection type	Cable with M8 male connector, 4-pin, Cable with receptacle M8, 4-pin, 0.5 m
Indication	LED
Synchronization	Via FlexChain (host)
Enclosure rating	IP65, IP67 1)
Circuit protection	U_V connections, reverse polarity protected Interference pulse suppression Outputs overcurrent and short-circuit protected

1) Operating in outdoor condition only with a external protection housing.

Protection class	III
Weight	464 g
Front screen	PMMA

¹⁾ Operating in outdoor condition only with a external protection housing.

Performance

Maximum range	10 m
Minimum range	≥ 0 m
Operating range	7 m
Scanning time	2.7 ms

Ambient data

EMC	EN 61000-6-2, EN 61000-6-4
Ambient operating temperature	-25 °C +55 °C
Ambient storage temperature	-25 °C +70 °C
Ambient light immunity	Direct: 30,000 lx ¹⁾
Vibration resistance	10-150 Hz 0.5 mm, IEC 60068-2-6
Shock load	10 g, 16 ms, DIN EN 60068-2-27

¹⁾ Sunlight.

Classifications

ECl@ss 5.0	27270910
ECl@ss 5.1.4	27270910
ECl@ss 6.0	27270910
ECl@ss 6.2	27270910
ECl@ss 7.0	27270910
ECl@ss 8.0	27270910
ECl@ss 8.1	27270910
ECl@ss 9.0	27270910
ECl@ss 10.0	27270910
ECl@ss 11.0	27270910
ETIM 5.0	EC002549
ETIM 6.0	EC002549
ETIM 7.0	EC002549
UNSPSC 16.0901	39121528

Dimensional drawing (Dimensions in mm (inch))

SLGxxx-xxxFxxxxxxx

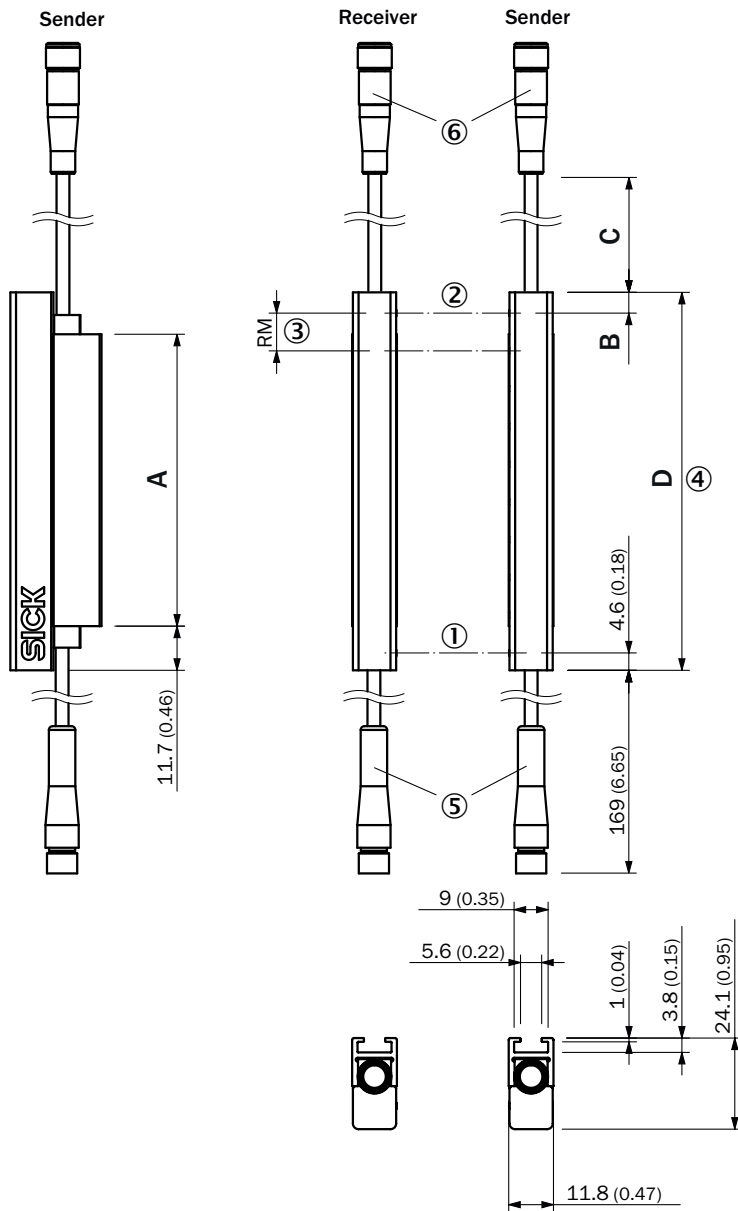

- ① First beam
- ② Last beam
- ③ Beam separation (RM)
- ④ Housing length
- ⑤ Cable with male connector, M8, 4-pin (fixed)
- ⑥ Cable with female connector, M8, 4-pin (0.5 m / 1.5 m)

Dimensions in mm (inch)		
	Length of stabilizer	Housing length
	A	D
SLGxxx-010xxxxxxx	77 (3.03)	99,2 (3.91)
SLGxxx-020xxxxxxx	178 (7.01)	199,2 (7.84)
SLGxxx-030xxxxxxx	276 (10.87)	299,2 (11.78)
SLGxxx-040xxxxxxx	376 (14.8)	399,2 (15.72)

Dimensions in mm (inch)		
SLGxxx- 05 0 xxxxxxx	475 (18.7)	499,2 (19.65)
SLGxxx- 06 0 xxxxxxx	576 (22.68)	599,2 (23.6)
SLGxxx- 07 0 xxxxxxx	676 (26.61)	699,2 (27.53)
SLGxxx- 08 0 xxxxxxx	776 (30.55)	799,2 (31.46)
SLGxxx- 100 xxxxxxx	975 (38.39)	999,2 (39.34)
SLGxxx- 120 xxxxxxx	1.175 (46.26)	1.199,2 (47.21)
SLGxxx- 140 xxxxxxx	1.374 (54,09)	1.399,2 (55.09)
	Distance: Housing edge - last beam	
	B¹⁾	
SLG 10 x-xxxxxxxxx	4,6 (0.18)	
SLG 25 x-xxxxxxxxx	19,6 (0.77)	
SLG 50 x-xxxxxxxxx	44,6 (1.76)	
¹⁾ for detection height less than 700 mm, the dimension deviates up to 1 mm from the dimensions specified here.		
	Length of cable	
	c	
SLGxxx-xxxxx A xxxx	500 (19.69)	
SLGxxx-xxxxx B xxxx	1.500 (59.06)	

Connection type and diagram

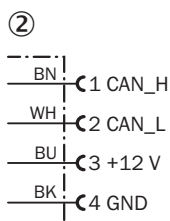
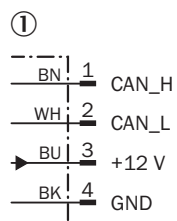
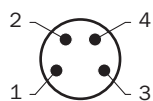

- ① Male connector M8, 4-pin
- ② Cable with receptacle M8, 4-pin

Funktionsprinzip

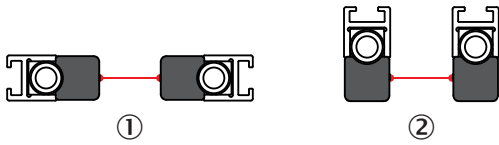

Slim & Flat



- ① Slim model = light emission on narrow side
- ② Flat model = light emission on broad side

Recommended accessories

Other models and accessories → www.sick.com/FlexChain

	Brief description	Type	Part no.
Mounting brackets and plates			
	Side mounting for switching automation light grids, SLG-2	BEF-NUT-SLG2	2111624
	Mounting bracket for switching automation light grids, SLG-2	BEF-SLG2-SET1	2111623

SICK AT A GLANCE

SICK is one of the leading manufacturers of intelligent sensors and sensor solutions for industrial applications. A unique range of products and services creates the perfect basis for controlling processes securely and efficiently, protecting individuals from accidents and preventing damage to the environment.

We have extensive experience in a wide range of industries and understand their processes and requirements. With intelligent sensors, we can deliver exactly what our customers need. In application centers in Europe, Asia and North America, system solutions are tested and optimized in accordance with customer specifications. All this makes us a reliable supplier and development partner.

Comprehensive services complete our offering: SICK LifeTime Services provide support throughout the machine life cycle and ensure safety and productivity.

For us, that is “Sensor Intelligence.”

WORLDWIDE PRESENCE:

Contacts and other locations –www.sick.com