



# RZT7-03ZRS-KR0

RZT7

SENSORS FOR T-SLOT CYLINDERS

**SICK**  
Sensor Intelligence.

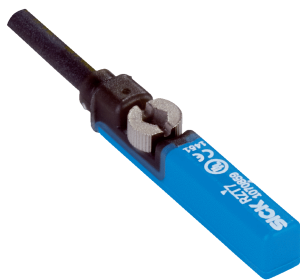

### Ordering information

Type	Part no.
RZT7-03ZRS-KR0	1070848

Other models and accessories → [www.sick.com/RZT7](http://www.sick.com/RZT7)



### Detailed technical data

#### Features

<b>Cylinder type</b>	T-slot
<b>Cylinder types with adapter</b>	Profile cylinder Tie rod cylinder Round body cylinder Dovetail groove cylinder SMC rail CDQ2 SMC rail ECDQ2
<b>Housing length</b>	29.5 mm
<b>Switching output</b>	Reed
<b>Switching frequency</b>	400 Hz
<b>Output function</b>	NO
<b>Electrical wiring</b>	AC/DC 3-wire
<b>Enclosure rating</b>	IP65 <sup>1)</sup> IP67

<sup>1)</sup> According to EN 60529.

#### Mechanics/electronics

<b>Supply voltage</b>	5 V AC/DC ... 30 V AC/DC
<b>Voltage drop</b>	≤ 0.1 V <sup>1)</sup>
<b>Continuous current I<sub>a</sub></b>	≤ 500 mA <sup>2)</sup> ≤ 300 mA <sup>3)</sup>
<b>Switching capacity</b>	≤ 6 W
<b>Protection class</b>	III
<b>Response sensitivity, typ.</b>	3 mT
<b>Overrun distance, typ.</b>	10 mm
<b>Reproducibility</b>	≤ 0.1 mT <sup>4)</sup>

<sup>1)</sup> For cable length up to 0.3 m.

<sup>2)</sup> DC.

<sup>3)</sup> AC.

<sup>4)</sup> U<sub>b</sub> and T<sub>a</sub> constant.

<b>Status indicator LED</b>	✓
<b>Reverse polarity protection</b>	✓
<b>Ambient operating temperature</b>	-30 °C ... +80 °C
<b>Shock and vibration resistance</b>	30 g, 11 ms / 10 ... 55 Hz, 1 mm
<b>EMC</b>	According to EN 60947-5-2
<b>Connection type</b>	Cable with connector M8, 3-pin, with knurled nuts, drag chain use, 0.5 m
<b>Connection type Detail</b>	
Conductor cross-section	0.14 mm <sup>2</sup>
Cable diameter	Ø 2.9 mm
Bending radius	With fixed installation > 3 x cable diameter For flexible use > 10 x cable diameter
Torsion force	± 270° / 10 cm
Torsion cycles	> 2,000,000
Cable outlet	Axial
<b>Material</b>	
Housing	Plastic
Cable	PUR
<b>UL File No.</b>	NRKH.E181493 & NRKH7.E181493

1) For cable length up to 0.3 m.

2) DC.

3) AC.

4) Ub and Ta constant.

## Classifications

<b>ECI@ss 5.0</b>	27270104
<b>ECI@ss 5.1.4</b>	27270104
<b>ECI@ss 6.0</b>	27270104
<b>ECI@ss 6.2</b>	27270104
<b>ECI@ss 7.0</b>	27270104
<b>ECI@ss 8.0</b>	27270104
<b>ECI@ss 8.1</b>	27270104
<b>ECI@ss 9.0</b>	27270104
<b>ECI@ss 10.0</b>	27270104
<b>ECI@ss 11.0</b>	27270104
<b>ETIM 5.0</b>	EC002544
<b>ETIM 6.0</b>	EC002544
<b>ETIM 7.0</b>	EC002544
<b>UNSPSC 16.0901</b>	39122230

**Installation note**

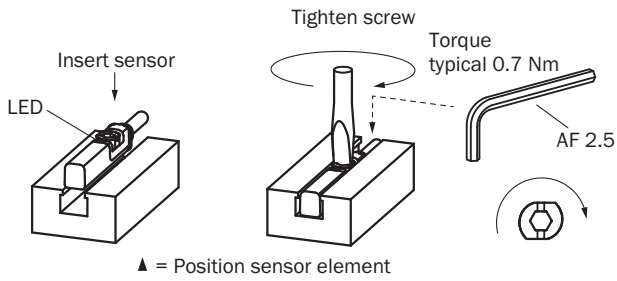

**Connection diagram**

Cd-036

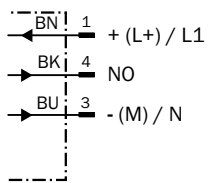

**Dimensional drawing** (Dimensions in mm (inch))

Cable with connector M8, with knurled nuts

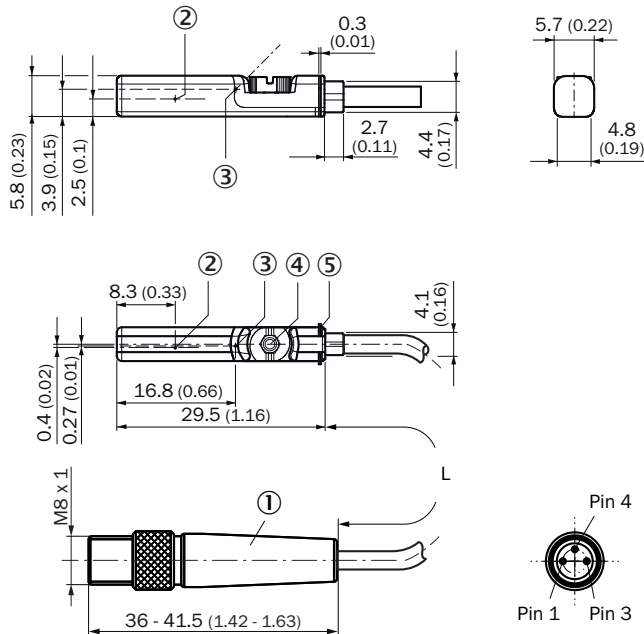







- ① Connection
- ② Position sensor element
- ③ Indication LED
- ④ Fixing screw SW 2.5
- ⑤ Retaining ribs

Part no.	Type	L	Number of cores	Supply voltage
1070857	RZT7-03ZUS-KR0	0.5 m	2	5 V AC/DC ... 30 V AC/DC
1070848	RZT7-03ZRS-KR0	0.5 m	3	5 V AC/DC ... 30 V AC/DC
1085067	RZT7-03ZRS-KRD	4 m	3	5 V AC/DC ... 30 V AC/DC

## Recommended accessories

Other models and accessories → [www.sick.com/RZT7](http://www.sick.com/RZT7)

	Brief description	Type	Part no.
<b>Brackets for cylinder sensors</b>			
	Mounting bracket for cylinder with dovetail slot, Aluminum, without mounting hardware	BEF-KHZ-ST1	2022703
	Mounting bracket for integrated profile cylinder/tie-rod cylinder, zinc diecast, mounting hardware included	BEF-KHZ-PT1	2022702
	1 piece, Mounting bracket on round body cylinder with piston diameter of 12 mm, ambient temperature min 0 °C max 50 °C, plastic, Aluminum	BEF-KHZ-RT-12	2077681
	1 piece, Mounting bracket on round body cylinder with piston diameter of 16 mm, ambient temperature min 0 °C max 50 °C, plastic, Aluminum	BEF-KHZ-RT-16	2077680
	1 piece, Mounting bracket on round body cylinder with piston diameter of 20 mm, ambient temperature min 0 °C max 50 °C, plastic, Aluminum	BEF-KHZ-RT-20	2077679
	1 piece, Mounting bracket on round body cylinder with piston diameter of 25 mm, ambient temperature min 0 °C max 50 °C, plastic, Aluminum	BEF-KHZ-RT-25	2077678
	1 piece, Mounting bracket on round body cylinder with piston diameter of 32 mm, ambient temperature min 0 °C max 50 °C, plastic, Aluminum	BEF-KHZ-RT-32	2077677
	1 piece, Mounting bracket on round body cylinder with piston diameter of 40 mm, ambient temperature min 0 °C max 50 °C, plastic, Aluminum	BEF-KHZ-RT-40	2077676
	1 piece, Mounting bracket on round body cylinder with piston diameter of 50 mm, ambient temperature min 0 °C max 50 °C, plastic, Aluminum	BEF-KHZ-RT-50	2077675
	1 piece, Mounting bracket on round body cylinder with piston diameter of 63 mm, ambient temperature min 0 °C max 50 °C, plastic, Aluminum	BEF-KHZ-RT-63	2077674
	1 piece, Mounting bracket on round body cylinder with piston diameter of 8 mm ... 130 mm, ambient temperature min -30 °C max 80 °C, stainless steel, Zinc cast	BEF-KHZ-RT1-130	2077684
	1 piece, Mounting bracket on round body cylinder with piston diameter of 8 mm ... 25 mm, ambient temperature min -30 °C max 80 °C, stainless steel, Zinc cast	BEF-KHZ-RT1-25	2077682
	1 piece, Mounting bracket on round body cylinder with piston diameter of 8 mm ... 63 mm, ambient temperature min -30 °C max 80 °C, stainless steel, Zinc cast	BEF-KHZ-RT1-63	2077683
	Mounting bracket for mounting on SMC rails CDQ2 (T-slot), Aluminum, without mounting hardware	BEF-KHZ-TT2	2046440
	Mounting bracket for mounting on SMC rails ECDQ2 (T-slot), Aluminum, without mounting hardware	BEF-KHZ-TT1	2046439

	Brief description	Type	Part no.
Device protection (mechanical)			
	Protective adapter, die-cast zinc, mounting hardware included	BEF-SG-MRZT	2077201
Plug connectors and cables			
	Head A: female connector, M8, 3-pin, straight, A-coded Head B: Flying leads Cable: Sensor/actuator cable, PUR, halogen-free, unshielded, 2 m	YF8U13-020UA1XLEAX	2094782
	Head A: female connector, M8, 3-pin, straight, A-coded Head B: Flying leads Cable: Sensor/actuator cable, PVC, unshielded, 2 m	YF8U13-020VA1XLEAX	2095860
	Head A: female connector, M8, 3-pin, straight, A-coded Head B: Flying leads Cable: Sensor/actuator cable, PUR, halogen-free, unshielded, 5 m	YF8U13-050UA1XLEAX	2094788
	Head A: female connector, M8, 3-pin, straight, A-coded Head B: Flying leads Cable: Sensor/actuator cable, PVC, unshielded, 5 m	YF8U13-050VA1XLEAX	2095884
	Head A: female connector, M8, 3-pin, angled, A-coded Head B: Flying leads Cable: Sensor/actuator cable, PUR, halogen-free, unshielded, 2 m	YG8U13-020UA1XLEAX	2094794
	Head A: female connector, M8, 3-pin, angled, A-coded Head B: Flying leads Cable: Sensor/actuator cable, PVC, unshielded, 2 m	YG8U13-020VA1XLEAX	2096165
	Head A: female connector, M8, 3-pin, angled, A-coded Head B: Flying leads Cable: Sensor/actuator cable, PUR, halogen-free, unshielded, 5 m	YG8U13-050UA1XLEAX	2095586
	Head A: female connector, M8, 3-pin, angled, A-coded Head B: Flying leads Cable: Sensor/actuator cable, PVC, unshielded, 5 m	YG8U13-050VA1XLEAX	2096166
	Head A: female connector, M8, 3-pin, straight Head B: - Cable: unshielded	DOS-0803-G	7902077
	Head A: female connector, M8, 3-pin, angled Head B: - Cable: unshielded	DOS-0803-W	7902078
	Head A: male connector, M8, 3-pin, straight Head B: - Cable: unshielded	STE-0803-G	6037322

## SICK AT A GLANCE

SICK is one of the leading manufacturers of intelligent sensors and sensor solutions for industrial applications. A unique range of products and services creates the perfect basis for controlling processes securely and efficiently, protecting individuals from accidents and preventing damage to the environment.

We have extensive experience in a wide range of industries and understand their processes and requirements. With intelligent sensors, we can deliver exactly what our customers need. In application centers in Europe, Asia and North America, system solutions are tested and optimized in accordance with customer specifications. All this makes us a reliable supplier and development partner.

Comprehensive services complete our offering: SICK LifeTime Services provide support throughout the machine life cycle and ensure safety and productivity.

For us, that is “Sensor Intelligence.”

## WORLDWIDE PRESENCE:

Contacts and other locations –[www.sick.com](http://www.sick.com)