

# PT200PSIG-2021-U3-H1143/X

## Pressure Transmitter – With Voltage Output (3-Wire)

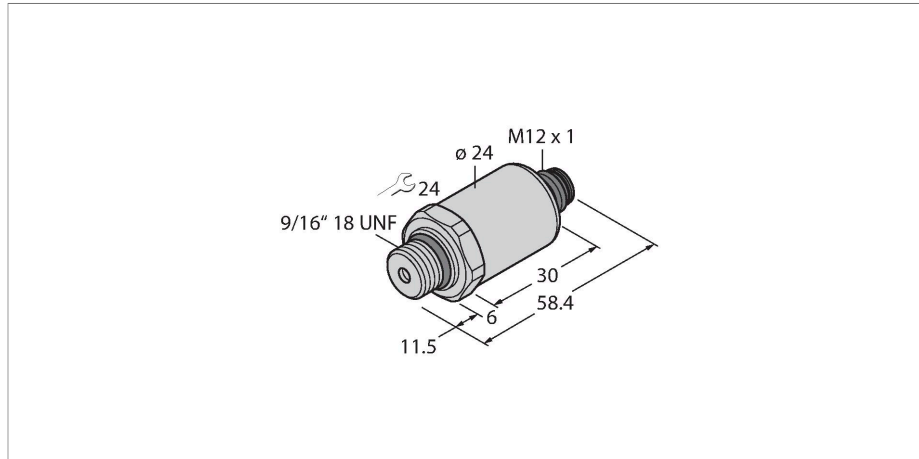

### Features

- Fully welded metal measuring cell
- Pressure range 0...200 psi rel.
- Pressure peak orifice
- 7...33 VDC
- Analog output 0...5 V
- Process connection 9/16"-18 UNF (SAE) male thread
- Plug-in device, M12 × 1

### Wiring diagram

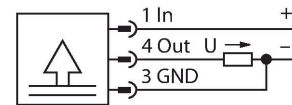

### Technical data

Type	PT200PSIG-2021-U3-H1143/X
Ident. no.	100001232
<b>Pressure range</b>	
Relative pressure bar	0...13.79 bar rel.
	0...200 psi
	0...1.38 MPa
Admissible overpressure	≤ 48 bar
Burst pressure	≥ 96 bar
Response time	< 2 ms, typ. 1 ms
Long-term stability	0.25 % FS, according to IEC EN 60770-1
<b>Power supply</b>	
Operating voltage	7...33 VDC
Current consumption	≤ 7 mA
Short-circuit/reverse polarity protection	yes / yes
Protection type and class	IP67 / III
Insulation voltage	750 VDC
<b>Outputs</b>	
Output 1	Analog output
Output function	Analog output voltage
<b>Analog output</b>	
Voltage output	0...5 V
Load	≤ 100 nF/>10 kΩ
Resolution	<± 0.1 % FS

### Functional principle

The pressure sensors in the PT...-2000 product series operate with a fully welded metal measuring cell in various pressure ranges of up to -1...1000 bar in 2-, 3- or even 4-wire technology. Depending on the sensor variant, the processed signal is available as an analog output signal (4...20 mA, 0...10 V, 0...5 V, 1...6 V, ratiometric) or as a digital IO-Link process parameter. The IO-Link sensor variants also have two independently configurable switching outputs. In addition to the standard variants, there are special sensors for uses such as ATEX areas or for oxygen applications. A wide range of process connections and electrical connections offer a high degree of flexibility in a wide range of applications.

## Technical data

Accuracy LHR	± 0.3 % FS BSL
<b>Temperature behaviour</b>	
Medium temperature	-40...+135 °C
Temperature coefficient	± 0.2 % of full scale/10 K
<b>Ambient conditions</b>	
Ambient temperature	-30...+85 °C
Storage temperature	-50...+100 °C
Vibration resistance	20 g, 15...2000 Hz, 15...25 Hz with amplitude +/- 15 mm, 1 octave/minute all 3 directions, 50 continuous loads, acc. to IEC 68-2-6
Shock resistance	100 g, 11 ms, half sinusoidal curve, all 6 directions, free fall from 1 m onto concrete (6x) , acc. to IEC 68-2-27
<b>Housing</b>	
Housing material	Stainless-steel/Plastic, 1.4404 (AISI 316L)/polyacrylamide 50 % GF UL 94 V-0
Pressure connection material	Stainless steel 1.4404 (AISI 316L)
Pressure transducer material	Stainless steel 1.4016 (AISI 430)
Process connection	9/16"-18 UNF male thread
Wrench size pressure connection / coupling nut	24
Electrical connection	Connector, M12 × 1
Max. tightening torque of housing nut	20 Nm
<b>Reference conditions acc. to IEC 61298-1</b>	
Temperature	15...+25 °C
Atmospheric pressure	860...1060 hPa abs.
Humidity	45...75 % rel.
Auxiliary power	24 VDC
Approvals	UL
MTTF	1238 years acc. to SN 29500 (Ed. 99) 40 °C