

PT0.6R-1503-I2-H1143/D840

Pressure Transmitter – With Current Output (2-Wire)

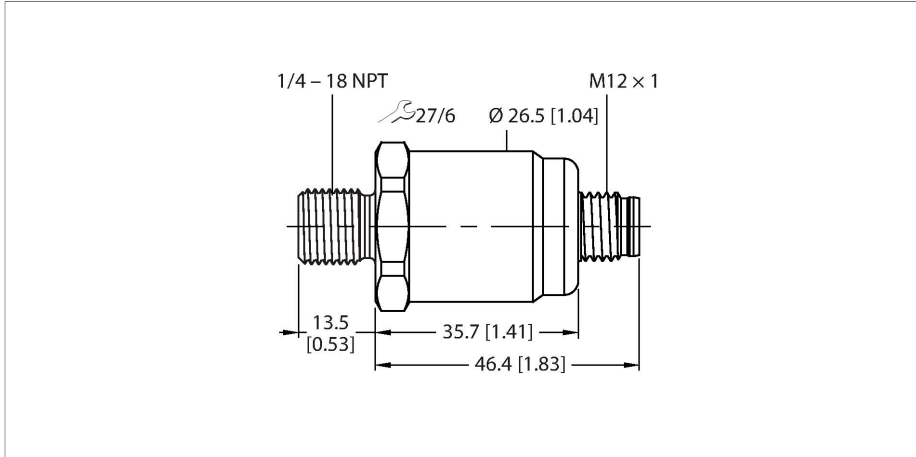

Technical data

Type	PT0.6R-1503-I2-H1143/D840
Ident. no.	100004654
Pressure range	
Relative pressure bar	0...0.6 bar rel.
	0...8.7 psi
	0...0.06 MPa
Admissible overpressure	≤ 2 bar
Permissible vacuum	- 0.3 bar
Burst pressure	≥ 2 bar
Response time	< 150 ms
Adjustment position	Vertical, pressure connection at bottom
Vertical position error, pressure connection at top	+ 0.2 mbar
Horizontal position error	+ 0.1 mbar
Long-term stability	0.25 % FS, , acc. to EN 60770-1
Power supply	
Operating voltage	10...30 VDC
Current consumption	≤ 23 mA
Short-circuit/reverse polarity protection	yes / yes
Protection type and class	IP67 / III
Insulation voltage	500 VDC
Outputs	
Output 1	Analog output

Features

- Ceramic measuring cell
- Extremely high measuring accuracy
- Compact and robust design
- Excellent temperature behavior
- Pressure range 0...600 mbar rel.
- 10...30 VDC
- Analog output 4...20 mA
- Process connection 1/4"-18 NPT male thread
- Plug-in device, M12 × 1

Wiring diagram

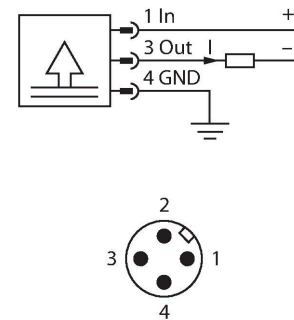

Functional principle

The pressure sensors in the PT...-1500 product series operate with a ceramic measuring cell in various micropressure ranges of up to -100...600 mbar in 2- or 3-wire technology. Depending on the sensor variant, the processed signal is available as an analog

Technical data

Analog output	
Current output	4...20 mA
Load	$\leq (\text{Supply voltage} - 10)/20 \text{ k}\Omega$
Resolution	$<\pm 0.1 \text{ \% FS}$
Accuracy LHR	$\pm 0.35 \text{ \% FS BSL}$
Temperature behaviour	
Medium temperature	-25...+85 °C
Temperature coefficient span TkS	$\pm 0.07 \text{ \% FS/10 K}$
Ambient conditions	
Ambient temperature	-25...+85 °C
Storage temperature	-40...+85 °C
Vibration resistance	20 g, 15...2000 Hz, 15...25 Hz with amplitude μ 15 mm, 1 octave/minute in all 3 directions, 50 continuous loads, according to IEC 68-2-6
Shock resistance	50 g, 6 ms, half sinusoidal curve, all 6 directions, free fall from 1 m onto concrete (6x) , acc. to IEC 68-2-27
Housing	
Housing material	Stainless-steel/Plastic, 1.4404 (AISI 316L)/polyacrylamide 50 % GF UL 94 V-0
Pressure connection material	Stainless steel 1.4404 (AISI 316L)
Pressure transducer material	Ceramics Al_2O_3
Sealing material	FPM
Process connection	1/4" NPT-18 male thread
Wrench size pressure connection / coupling nut	27
Electrical connection	Connector, M12 × 1
Max. tightening torque of housing nut	27 Nm
Reference conditions acc. to IEC 61298-1	
Temperature	15...+25 °C
Atmospheric pressure	800...1060 hPa abs.
Humidity	45 % rel.
Auxiliary power	24 VDC
MTTF	965 years acc. to SN 29500 (Ed. 99) 40 °C

output signal (4...20 mA, 0...10 V, 0...5 V, ratiometric).

In addition to the standard variants, there are special sensors for uses such as ATEX areas. A wide range of process connections and electrical connections offer a high degree of flexibility in a wide range of applications.