

# PS510-250-03-LI2UPN8-H1141/X

## Pressure sensor – Relative Pressure: 0...250 Bar

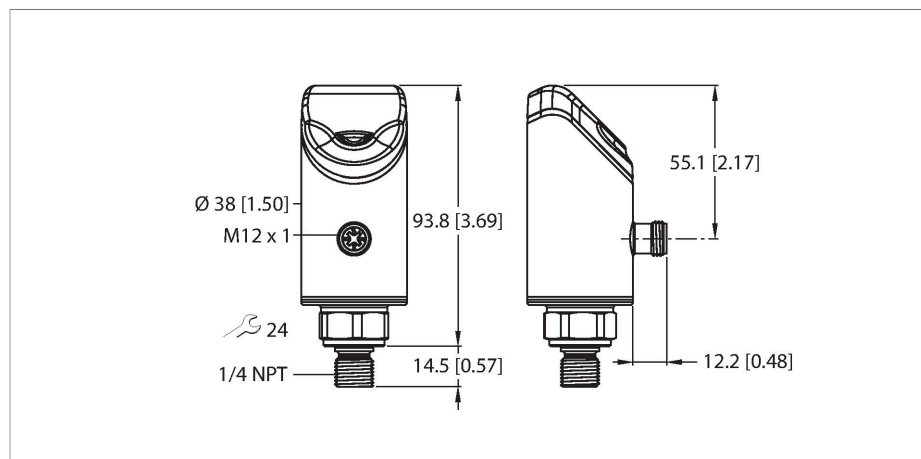

### Technical data

Type	PS510-250-03-LI2UPN8-H1141/X
Ident. no.	100004737
Medium temperature	-30...+80 °C
Application area	Liquids and gases
<b>Pressure range</b>	
Relative pressure bar	0...250 bar rel.
	0...3625.95 psi
	0...25 MPa
Admissible overpressure	≤ 750 bar
Burst pressure	≥ 1000 bar
Response time	≤ 3 ms
<b>Electrical data</b>	
Operating voltage	18...33 VDC
Short-circuit/reverse polarity protection	yes, cyclic / yes (voltage supply)
Capacitive load	100 nF
Insulation class	III
<b>Outputs</b>	
Output 1	Switching output or IO-Link mode
Output 2	Analog output (current/voltage) or switching output
<b>Switching output</b>	
Communication protocol	IO-Link
Output function	NO/NC, PNP/NPN
Accuracy	± 0.25 % of final value BSL

### Features

- 4-digit, two-colored, 14-segment display, rotatable by 180°
- Housing is rotatable after plugging the process connection
- Metal measuring cell
- Peak pressure aperture
- 18...33 VDC
- NO/NC contact, PNP/NPN output, analog output (current/voltage), IO-Link
- Process connection 1/4" NPT male thread
- Connector device, M12 × 1

### Wiring diagram

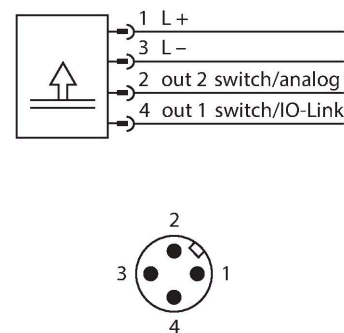

### Functional principle

The pressure sensors from the P510 product series operate with fully welded metal measuring cells. As a result of the pressure acting on the metal substrate, a signal that is proportional to the pressure is generated and processed electronically. The processed

## Technical data

signal is available either as a switching or an analog output with an accuracy of 0.25% of full scale. The rotatable sensor body and a variety of process connections guarantee flexible process integration.

Rated operational current	0.25 A
Switching frequency	≤ 300 Hz
Switching point distance	≥ 0.5 %
Switch point:	(min. + 0.005 x range) up to 100 % of full scale
Release point(s)	min. up to (SP - 0.005 × range)
Switching cycles	≥ 100 mil.
<b>Analog output</b>	
Current output	4...20 mA
High level signal current	20.5 mA
Low level signal current	3.8 mA
Load resistance, current output	≤ 0.5 kΩ
Voltage output	0...10 V
Load resistance voltage output	≥ 8 kΩ
Accuracy LHR	± 0.25 % FS BSL
<b>IO-Link</b>	
IO-Link specification	V 1.1
IO-Link port type	Class A
Transmission physics	corresponds to 3-wire physics (PHY2)
Frame type	2.2
Transmission rate	COM 2/38.4 kbps
Process data width	16 bit
Measured value information	14 bit
Switchpoint information	2 bit
Programming	FDT/DTM
Accuracy	± 0.25 % of full scale BSL
Included in the SIDI GSDML	Yes
<b>Programming</b>	
Programming options	start/end value analog output; switch/release points; PNP/NPN; NO/NC contact; hysteresis/window function; damping; pressure unit; peak pressure memory
<b>Mechanical data</b>	
Housing material	Stainless-steel/Plastic, 1.4404 (AISI 316L)/Grilamid TR90 UV
Materials (contact with media)	Stainless steel 1.4404 (AISI 316L)/1.4542 (AISI 630)
Process connection	1/4" NPT male thread
Wrench size pressure connection / coupling nut	24

## Technical data

Max. tightening torque of housing nut	35 Nm
Electrical connection	Connector, M12 × 1
Protection class	IP6K6K / 6K7 / 6K9K
<b>Environmental conditions</b>	
Ambient temperature	-40...+80 °C
Storage temperature	-40...+100 °C
Shock resistance	50 g (11 ms) , EN 60068-2-27
EMV	EN 61000-4-2 ESD:4 kV CD / 8 kV AD EN 61000-4-3 HF radiated: 15 V/m EN 61000-4-4 Burst: 2 kV EN 61000-4-6 HF cable bound: 10 V EN 61000-6-2 0.5 kV, 42 Ω EN 61326-2-3
<b>Reference conditions acc. to IEC 61298-1</b>	
Temperature	15...+25 °C
Atmospheric pressure	860...1030 hPa abs.
Humidity	45...75 % rel.
Auxiliary power	24 VDC
<b>Display functions</b>	
Display	4-digit 12-segment display, rotatable by 180°, red or green
Switching state	2 × LEDs, Yellow
Unit display	5 x LEDs green (bar, psi, kPa, MPa, misc)
<b>Temperature behaviour</b>	
Temperature coefficient span $T_{ks}$	± 0.1 % of full scale/10 K
Temperature coefficient zero point $T_{k0}$	± 0.1 % of full scale/10 K
MTTF	100 years acc. to SN 29500 (Ed. 99) 40 °C