

PS016D-501T-LI2UPN8X-H1141

Differential Pressure Sensor – With current output and PNP/NPN Transistor Switching Output

Output 2 Programmable as Switching Output

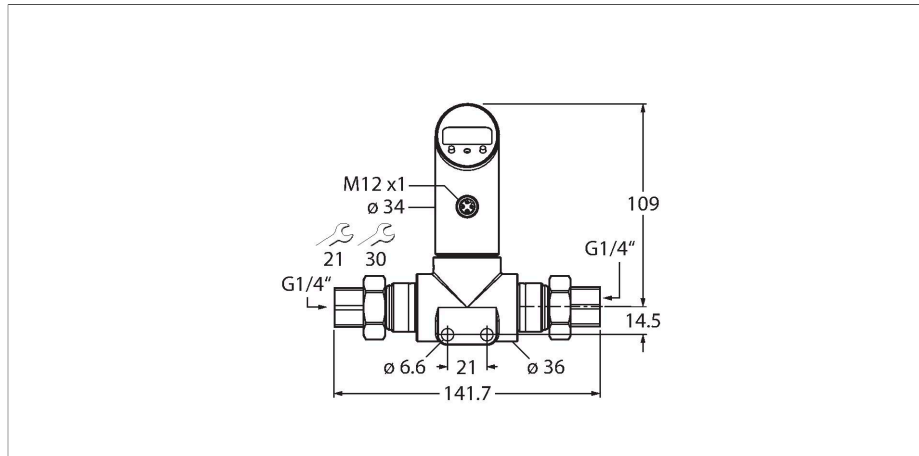

Features

- Pressure monitoring in harsh industrial environments
- Housing is rotatable after plugging the process connection
- Reading of adjusted values without tool
- High-side switch
- Recessed pushbutton, keylock and password for secure programming
- Permanent indication of pressure (bar, psi, kPa, MPa, misc)
- Peak pressure memory
- Pressure range 0...16 bar difference

Wiring diagram

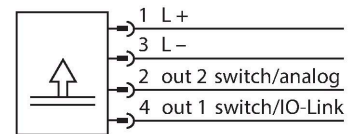

Functional principle

The PSD differential pressure sensors have two pressure connections with ceramic measuring cells to detect different pressures, from which the difference is formed. As a result of the pressure acting on the measuring cells, a signal that is proportional to the pressure is generated and electronically processed internally. Depending on the sensor variant, either switching or analog signals are available. All PSD variants have IO-Link. The PSD sensors operate in various positive pressure ranges up to a differential of 250 bar. The connection with higher pressure can be configured via the menu (High-Site-Switch).

Technical data

Type	PS016D-501T-LI2UPN8X-H1141
Ident. no.	6834065
Pressure range	
Relative pressure bar	0...16 bar rel.
	0...232.06 psi
	0...1.6 MPa
Admissible overpressure	≤ 80 bar
Burst pressure	≥ 80 bar
Response time	< 3 ms
Power supply	
Operating voltage	18...30 VDC
Current consumption	≤ 50 mA
Voltage drop at I _o	≤ 2.5 V
Protective measure	SELV; PELV according to EN 50178
Short-circuit/reverse polarity protection	yes / yes
Protection type and class	IP67 / IP69K / III
Outputs	
Output 1	Switching output or IO-Link mode
Output 2	analog or switching output
Switching output	
Communication protocol	IO-Link

Technical data

Output function	NO/NC, PNP/NPN
Accuracy	± 1 % of final value BSL
Rated operational current	0.2 A
Switching frequency	≤ 180 Hz
Switching point distance	≥ 0.5 %
Switch point:	(min. + 0.005 × range) up to 100% of full scale
Release point(s)	min. up to (SP - 0.005 × range)
Switching cycles	≥ 100 mil.
Analog output	
Current output	4...20 mA
Load	≤ 0.5 kΩ
Accuracy LHR	± 1 % FS BSL
Included in the SIDI GSDML	Yes
Temperature behaviour	
Medium temperature	-40...+85 °C
Temperature coefficient zero point T _{k0}	± 0.3 % of full scale/10 K
Temperature coefficient span T _{ks}	± 0.3 % of full scale/10 K
Ambient conditions	
Ambient temperature	-40...+80 °C
Storage temperature	-40...+80 °C
Vibration resistance	20 g (9...2000 Hz), according to IEC 60068-2-6
Shock resistance	50 g (11 ms) , acc. to IEC 60068-2-27
EMV	EN 61000-4-2 ESD: 4 kV CD/8 kV AD EN 61000-4-3 HF Radiated: 15 V/m EN 61000-4-4 Burst: 2 kV EN 61000-4-5 Surge: 1 kV, 42 Ohm EN 61000-4-6 HF Cable-bound: 10 V
Housing	
Housing material	Stainless-steel/Plastic, 1.4305 (AISI 303)
Pressure connection material	Stainless steel 1.4305 (AISI 303)
Pressure transducer material	Ceramics Al ₂ O ₃
Sealing material	FPM spez.
Process connection	G 1/4" female thread
Wrench size pressure connection / coupling nut	21/ 30
Electrical connection	Connector, M12 × 1
Max. tightening torque of housing nut	35 Nm

Technical data

Reference conditions acc. to IEC 61298-1	
Temperature	15...+25 °C
Atmospheric pressure	860...1060 hPa abs.
Humidity	45...75 % rel.
Auxiliary power	24 VDC
Display	4-digit 7-segment display, rotatable by 180°, disengageable
Switching state	2 × LEDs, Yellow
Unit display	5 x LEDs green (bar, psi, kPa, MPa, misc)
Programming options	start/end value analog output; switch/release points; PNP/NPN; NO/NC contact; hysteresis/window function; damping; pressure unit; peak pressure memory