

# REI-E-113T10C-2B5000-H1181

## Incremental Encoder

### Efficiency Line

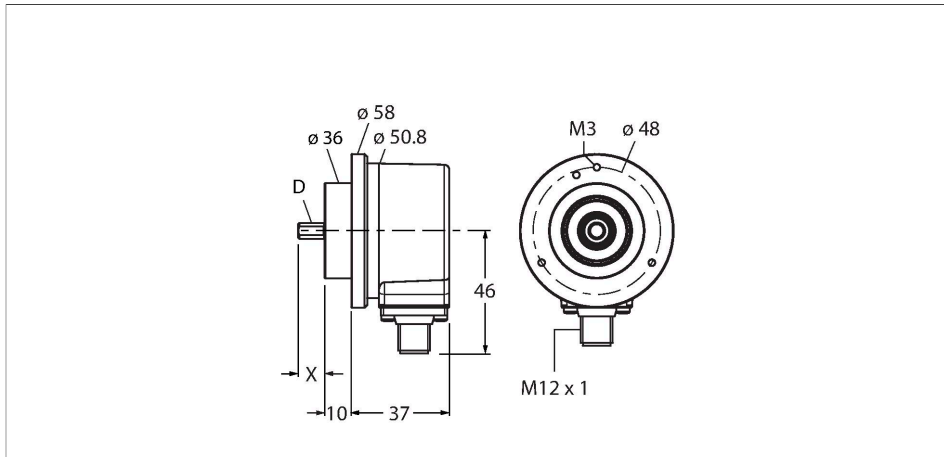

### Features

- Clamping flange, Ø 58 mm
- Solid shaft, Ø 10 mm × 20 mm
- Optical measuring principle
- Shaft material: stainless steel
- Protection class IP64 on housing and shaft side
- -20...+70 °C
- Max. 4500 rpm (continuous operation 3000 rpm)
- 10...30 VDC
- Male connector, M12 x 1, 8-pole
- Push-pull, with inverted signals
- Pulse frequency max. 300 kHz
- 5000 pulses per revolution

### Technical data

Type	REI-E-113T10C-2B5000-H1181
Ident. no.	100011563
Measuring principle	Optical
Max. Rotational Speed	4500 rpm
Moment of inertia of the rotor	$1.8 \times 10^{-6} \text{ kgm}^2$
Starting torque	< 0.05 Nm
Ambient temperature	-20...+70 °C
Operating voltage	10...30 VDC
No-load current	≤ 100 mA
Output current	≤ 30 mA
Short-circuit protection	yes
Wire breakage/Reverse polarity protection	yes
Output type	Incremental
Resolution, incremental	5000 ppr
Pulse frequency max.	300 kHz
Signal level high	min. $U_B - 1 \text{ V}$
Signal level low	max. 0.5 V
Output function	Push-Pull/HTL, with inverted signals
Design	Solid shaft
Flange type	Clamping flange
Flange diameter	Ø 58 mm
Shaft Type	Solid shaft
Shaft diameter D [mm]	10

### Wiring diagram



## Technical data

Wavelength L [mm]	20
Shaft material	Stainless steel
Housing material	Die-cast zinc
Electrical connection	Connector, M12 × 1
	8-pin
Axial shaft load	40 N
Radial shaft load	80 N
Vibration resistance (EN 60068-2-6)	10 g (100 m/s <sup>2</sup> ), 10...2000 Hz
Shock resistance (EN 60068-2-27)	1000 m/s <sup>2</sup> , 6 ms
Protection class	IP64
Protection class shaft	IP64

## Accessories

<p><b>RCS-19-10-10</b> 1545356</p> <p>Bellows coupling, outer diameter: 19 mm, bore diameter: 10 mm/10 mm</p>	<p><b>RCS-19-10-08</b> 1545357</p> <p>Bellows coupling, outer diameter: 19 mm, bore diameter: 10 mm/8 mm</p>
<p><b>RCS-19-10-06</b> 1545358</p> <p>Bellows coupling, outer diameter: 19 mm, bore diameter: 10 mm/6 mm</p>	<p><b>RCS-19-12-10</b> 1545355</p> <p>Bellows coupling, outer diameter: 19 mm, bore diameter: 12 mm/10 mm</p>
<p><b>RMW-5</b> 1544647</p> <p>Aluminum measuring wheel (cross-knurled) for encoders, perimeter 0.5 m, width 25 mm, D = 10 mm</p>	<p><b>RMW-6</b> 1544648</p> <p>Aluminum/polyurethane measuring wheel (smooth) for encoders, perimeter 0.5 m, width 25 mm, temp. range -30...+80 °C, D = 10 mm</p>
<p><b>RMW-7</b> 1544649</p> <p>Aluminum/Vulkollan measuring wheel (smooth) for encoders, perimeter 0.5 m, width 25 mm, temp. range -30...+80 °C, D = 10 mm</p>	<p><b>RMW-8</b> 1544650</p> <p>Aluminum measuring wheel with napped rubber surface (polyurethane) for encoders, perimeter 0.5 m, width 25 mm, temp. range -30...+80 °C, D = 10 mm</p>
<p><b>RMW-2</b> 1544644</p> <p>Aluminum measuring wheel (cross-knurled) for encoders, perimeter 0.2 m, width 12 mm, D = 10 mm</p>	<p><b>RMW-3</b> 1544645</p> <p>Aluminum measuring wheel (rubber smooth) for encoders, perimeter 0.2 m, width 12 mm, temp. range -30...+80 °C, D = 10 mm</p>

RMW-4 1544646

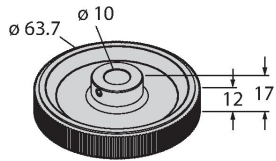

Aluminum measuring wheel (rubber grooved) for encoders, perimeter 0.2 m, width 12 mm, temp.range -30...+80 °C, D = 10 mm

RMW-02-5-10 1546682

## Wiring accessories

Dimension drawing	Type	Ident. no.	
	RKC8T-2/TXL	6625142	



Connection cable, female M12, straight, 8-pin, cable length: 2 m, sheath material: PUR, black; cULus approval; other cable lengths and qualities available, see [www.turck.com](http://www.turck.com)