

REI-E-113T12S-2B360-H1181

Incremental Encoder

Efficiency Line

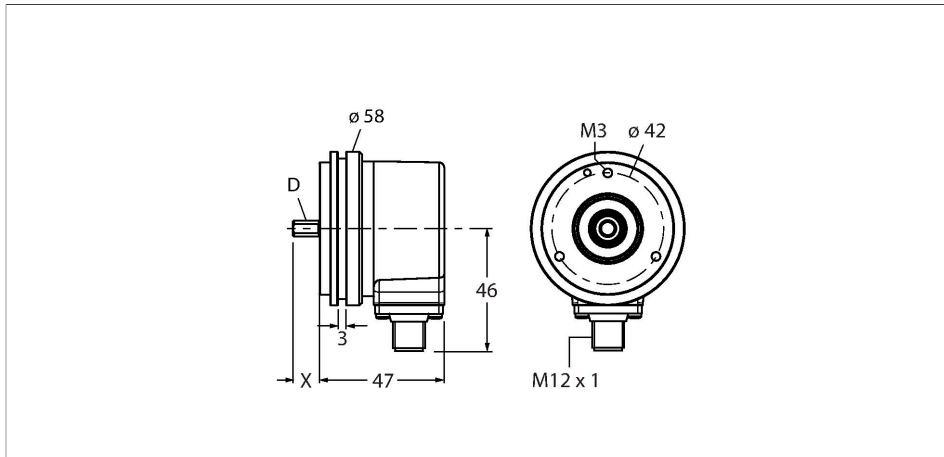

Features

- Synchro flange, Ø 58 mm
- Solid shaft, Ø 12 mm × 20 mm
- Optical measuring principle
- Shaft material: stainless steel
- Protection class IP64 on housing and shaft side
- -20...+70 °C
- Max. 4500 rpm (continuous operation 3000 rpm)
- 10...30 VDC
- Male connector, M12 x 1, 8-pole
- Push-pull, with inverted signals
- Pulse frequency max. 300 kHz
- 360 pulses per revolution

Technical data

Type	REI-E-113T12S-2B360-H1181
Ident. no.	100011582
Measuring principle	Optical
Max. Rotational Speed	4500 rpm
Moment of inertia of the rotor	$1.8 \times 10^{-6} \text{ kgm}^2$
Starting torque	< 0.05 Nm
Ambient temperature	-20...+70 °C
Operating voltage	10...30 VDC
No-load current	≤ 100 mA
Output current	≤ 30 mA
Short-circuit protection	yes
Wire breakage/Reverse polarity protection	yes
Output type	Incremental
Resolution, incremental	360 ppr
Pulse frequency max.	300 kHz
Signal level high	min. $U_b - 1 \text{ V}$
Signal level low	max. 0.5 V
Output function	Push-Pull/HTL, with inverted signals
Design	Solid shaft
Flange type	Synchro flange
Flange diameter	Ø 58 mm
Shaft Type	Solid shaft
Shaft diameter D [mm]	12

Wiring diagram



Technical data

Wavelength L [mm]	20
Shaft material	Stainless steel
Housing material	Die-cast zinc
Electrical connection	Connector, M12 × 1
	8-pin
Axial shaft load	40 N
Radial shaft load	80 N
Vibration resistance (EN 60068-2-6)	10 g (100 m/s ²), 10...2000 Hz
Shock resistance (EN 60068-2-27)	1000 m/s ² , 6 ms
Protection class	IP64
Protection class shaft	IP64

Accessories

RCS-19-12-12 1545354

Bellows coupling, outer diameter: 19 mm, bore diameter: 12 mm/12 mm

RCS-19-12-10 1545355

Bellows coupling, outer diameter: 19 mm, bore diameter: 12 mm/10 mm

Wiring accessories

Dimension drawing	Type	Ident. no.	
	RKC8T-2/TXL	6625142	Connection cable, female M12, straight, 8-pin, cable length: 2 m, sheath material: PUR, black; cULus approval; other cable lengths and qualities available, see www.turck.com