

# REI-E-114I12S1-2B5000-H1181

## Incremental Encoder

### Efficiency Line

### Features

- Flange with mounting element
- Hollow shaft, Ø 12 mm
- Optical measuring principle
- Shaft material: stainless steel
- Protection class IP64 on housing and shaft side
- -20...+70 °C
- Max. 4500 rpm (continuous operation 3000 rpm)
- 10...30 VDC
- Male connector, M12 x 1, 8-pole
- Push-pull, with inverted signals
- Pulse frequency max. 300 kHz
- 5000 pulses per revolution

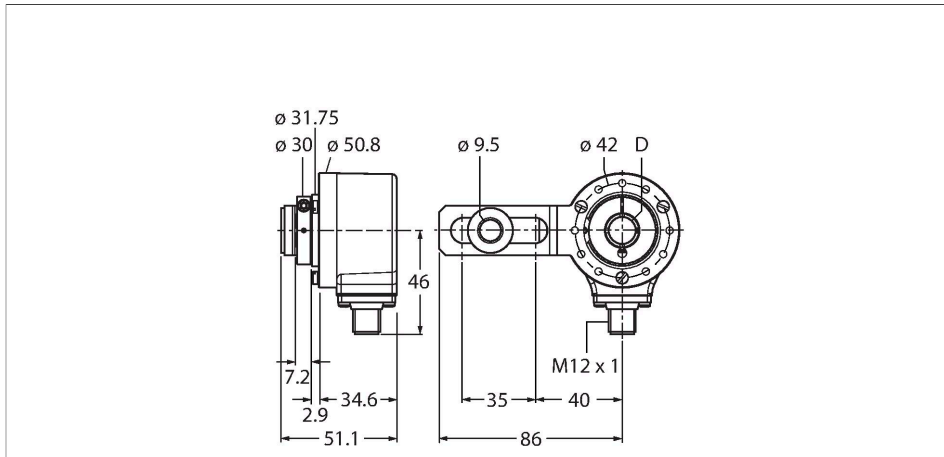

### Technical data

Type	REI-E-114I12S1-2B5000-H1181
Ident. no.	100011689
Measuring principle	Optical
Max. Rotational Speed	4500 rpm
Moment of inertia of the rotor	6 x 10 <sup>-6</sup> kgm <sup>2</sup>
Starting torque	< 0.05 Nm
Ambient temperature	-20...+70 °C
Operating voltage	10...30 VDC
No-load current	≤ 100 mA
Output current	≤ 30 mA
Short-circuit protection	yes
Wire breakage/Reverse polarity protection	yes
Output type	Incremental
Resolution, incremental	5000 ppr
Pulse frequency max.	300 kHz
Signal level high	min. U <sub>B</sub> - 1 V
Signal level low	max. 0.5 V
Output function	Push-Pull/HTL, with inverted signals
Design	Hollow shaft
Flange type	Flange with mounting element
Flange diameter	Ø 50.8 mm
Shaft Type	Hollow shaft
Shaft diameter D [mm]	12

### Wiring diagram



## Technical data

Shaft material	Stainless steel
Housing material	Die-cast zinc
Electrical connection	Connector, M12 × 1
	8-pin
Axial shaft load	40 N
Radial shaft load	80 N
Vibration resistance (EN 60068-2-6)	10 g (100 m/s <sup>2</sup> ), 10...2000 Hz
Shock resistance (EN 60068-2-27)	1000 m/s <sup>2</sup> , 6 ms
Protection class	IP64
Protection class shaft	IP64

## Accessories

<p><b>RME-1</b></p>	<p><b>1544612</b></p> <p>Stainless steel stator coupling for hollow shaft encoders, reference diameter, 65 mm, for highly dynamic, standard applications with axial and radial play</p>	<p><b>RME-2</b></p>	<p><b>1544613</b></p> <p>Stainless steel stator coupling for hollow shaft encoders, reference diameter 63 mm, for applications with high demands on accuracy</p>
<p><b>RME-4</b></p>	<p><b>1544615</b></p> <p>Stainless steel mounting panel for hollow shaft encoders, reference diameter 80...170 mm, for low dynamic applications with axial and radial play</p>	<p><b>RME-7</b></p>	<p><b>1544618</b></p> <p>Stainless steel stator coupling for hollow shaft encoders, reference diameter 65 mm, for highly dynamic applications with axial and radial play</p>
<p><b>RME-8</b></p>	<p><b>1544619</b></p> <p>Stainless steel mounting panel for hollow shaft encoders, reference diameter 65...91.5 mm, for applications with axial and radial play at constant rotation speed</p>	<p><b>RME-9</b></p>	<p><b>1544620</b></p> <p>Stainless steel mounting panel for hollow shaft encoders, reference diameter 64.5 mm, for low dynamic applications with axial and radial play</p>

RME-13

1544624



Plastic mounting element for hollow shaft encoders, pitch diameter 42 mm, for applications with limited axial play, low dynamics and limited mounting space

RME-14

1544625

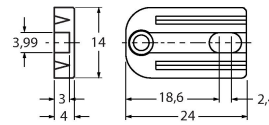

Plastic mounting element for hollow shaft encoders, pitch diameters 44 mm, 60 mm, 63 mm, 65 mm, for low dynamic applications with high axial play.

## Wiring accessories

Dimension drawing

Type

Ident. no.

RKC8T-2/TXL

6625142

Connection cable, female M12, straight, 8-pin, cable length: 2 m, sheath material: PUR, black; cULus approval; other cable lengths and qualities available, see [www.turck.com](http://www.turck.com)

