

REI-E-114I10E-2B512-H1181

Incremental Encoder

Efficiency Line

Features

- Flange with stator coupling, Ø 63 mm
- Hollow shaft, Ø 10mm
- Optical measuring principle
- Shaft material: stainless steel
- Protection class IP64 on housing and shaft side
- -20...+70 °C
- Max. 4500 rpm (continuous operation 3000 rpm)
- 10...30 VDC
- Male connector, M12 x 1 , 8-pole
- Push-pull, with inverted signals
- Pulse frequency max. 300 kHz
- 512 pulses per revolution

Wiring diagram

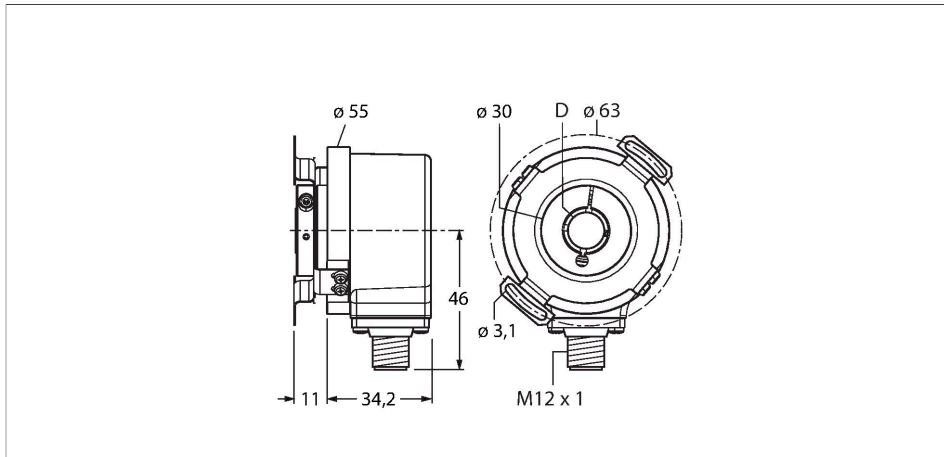
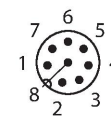
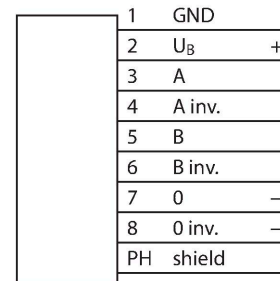

Technical data

Type	REI-E-114I10E-2B512-H1181
Ident. no.	100011763
Measuring principle	Optical
Max. Rotational Speed	4500 rpm
Moment of inertia of the rotor	6 x 10 ⁻⁶ kgm ²
Starting torque	< 0.05 Nm
Ambient temperature	-20...+70 °C
Operating voltage	10...30 VDC
No-load current	≤ 100 mA
Output current	≤ 30 mA
Short-circuit protection	yes
Wire breakage/Reverse polarity protection	yes
Output type	Incremental
Resolution, incremental	512 ppr
Pulse frequency max.	300 kHz
Signal level high	min. U _b - 1 V
Signal level low	max. 0.5 V
Output function	Push-Pull/HTL, with inverted signals
Design	Hollow shaft
Flange type	Flange with stator coupling
Flange diameter	Ø 63 mm
Shaft Type	Hollow shaft
Shaft diameter D [mm]	10

Technical data

Shaft material	Stainless steel
Housing material	Die-cast zinc
Electrical connection	Connector, M12 × 1
	8-pin
Axial shaft load	40 N
Radial shaft load	80 N
Vibration resistance (EN 60068-2-6)	10 g (100 m/s ²), 10...2000 Hz
Shock resistance (EN 60068-2-27)	1000 m/s ² , 6 ms
Protection class	IP64
Protection class shaft	IP64

Accessories

<p>RME-1</p>	<p>1544612</p> <p>Stainless steel stator coupling for hollow shaft encoders, reference diameter, 65 mm, for highly dynamic, standard applications with axial and radial play</p>
<p>RME-2</p>	<p>1544613</p> <p>Stainless steel stator coupling for hollow shaft encoders, reference diameter 63 mm, for applications with high demands on accuracy</p>
<p>RME-4</p>	<p>1544615</p> <p>Stainless steel mounting panel for hollow shaft encoders, reference diameter 80...170 mm, for low dynamic applications with axial and radial play</p>
<p>RME-7</p>	<p>1544618</p> <p>Stainless steel stator coupling for hollow shaft encoders, reference diameter 65 mm, for highly dynamic applications with axial and radial play</p>
<p>RME-8</p>	<p>1544619</p> <p>Stainless steel mounting panel for hollow shaft encoders, reference diameter 65...91.5 mm, for applications with axial and radial play at constant rotation speed</p>
<p>RME-9</p>	<p>1544620</p> <p>Stainless steel mounting panel for hollow shaft encoders, reference diameter 64.5 mm, for low dynamic applications with axial and radial play</p>

RME-13

1544624



Plastic mounting element for hollow shaft encoders, pitch diameter 42 mm, for applications with limited axial play, low dynamics and limited mounting space

RME-14

1544625

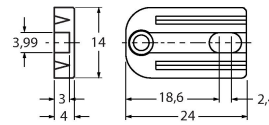

Plastic mounting element for hollow shaft encoders, pitch diameters 44 mm, 60 mm, 63 mm, 65 mm, for low dynamic applications with high axial play.

Wiring accessories

Dimension drawing

Type

Ident. no.

RKC8T-2/TXL

6625142

Connection cable, female M12, straight, 8-pin, cable length: 2 m, sheath material: PUR, black; cULus approval; other cable lengths and qualities available, see www.turck.com

