

REI-E-112I8E-2B512-C

Incremental Encoder

Efficiency Line

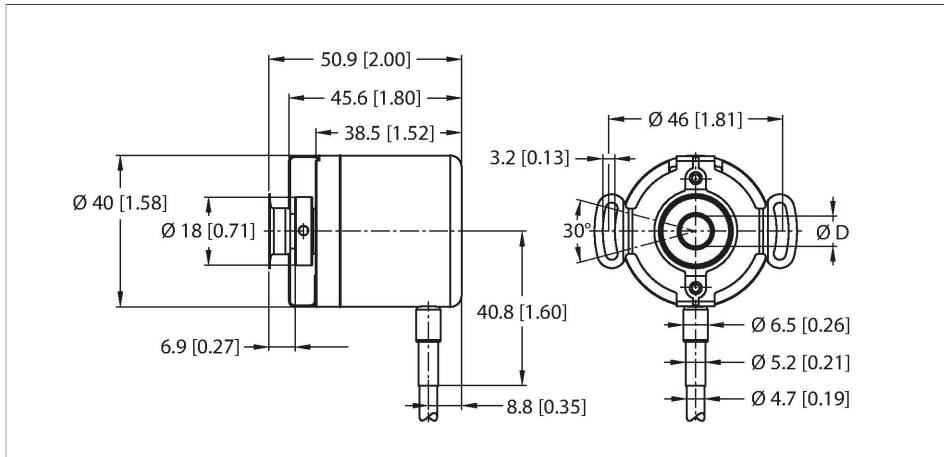

Features

- Flange with stator coupling, Ø 46 mm
- Blind hole hollow shaft, Ø 8 mm (plug-in depth max. 18 mm)
- Optical measuring principle
- Shaft material: stainless steel
- Protection class IP64 on housing and shaft side
- -20...+70 °C
- Max. 4500 rpm
- 10...30 VDC
- Cable connection, 8-pole
- Push-pull, with inverted signals
- Pulse frequency max. 300 kHz
- 512 pulses per revolution

Technical data

Type	REI-E-112I8E-2B512-C
Ident. no.	100012058
Measuring principle	Optical
Max. Rotational Speed	4500 rpm
Moment of inertia of the rotor	0.2 x10 ⁻⁶ kgm ²
Starting torque	< 0.05 Nm
Ambient temperature	-20...+70 °C
Operating voltage	10...30 VDC
No-load current	≤ 100 mA
Output current	≤ 30 mA
Short-circuit protection	yes
Wire breakage/Reverse polarity protection	yes
Output type	Incremental
Resolution, incremental	512 ppr
Pulse frequency max.	300 kHz
Signal level high	min. U _B - 1 V
Signal level low	max. 0.5 V
Output function	Push-Pull/HTL, with inverted signals
Design	Hollow shaft
Flange type	Flange with stator coupling
Flange diameter	Ø 46 mm
Shaft Type	Hollow shaft
Shaft diameter D [mm]	8

Wiring diagram

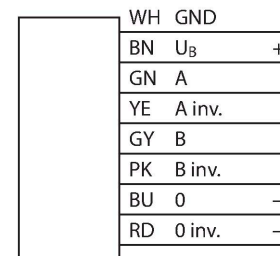

Technical data

Wavelength L [mm]	18
Shaft material	Stainless steel
Housing material	Aluminium
Electrical connection	Cable
	radial
cable length	2 m
Axial shaft load	20 N
Radial shaft load	40 N
Vibration resistance (EN 60068-2-6)	100 m/s ² , 55...2000 Hz
Shock resistance (EN 60068-2-27)	1000 m/s ² , 6 ms
Protection class	IP64
Protection class shaft	IP64