

RI360P0-QR24M0-0064X2-H1181

Contactless Encoder – Incremental: 64 ppr

Premium Line

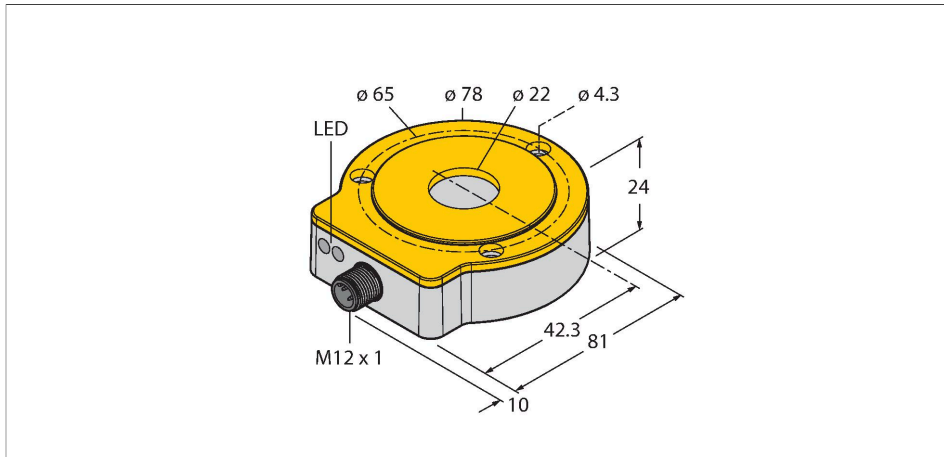

Features

- Compact, rugged housing
- Many mounting possibilities
- Status displayed via LED
- Immune to electromagnetic interference
- Position of z-track can be set via Easy-Teach
- Burst function, absolute angular position output incrementally via Easy-Teach pulse
- 10...30 VDC
- Male M12 x 1, 8-pin
- Push-pull A, B, Z, A (inverse), B (inverse)

Wiring diagram

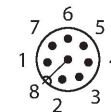
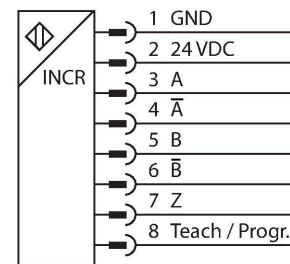

Technical data

Type	RI360P0-QR24M0-0064X2-H1181
Ident. no.	1593107
Measuring principle	Inductive
Max. Rotational Speed	10000 rpm
	Determined with standardized construction, with a steel shaft Ø 20 mm, L = 50 mm and reducer Ø 20 mm
Starting torque shaft load (radial / axial)	not applicable, because of contactless measuring principle
Nominal distance	1.5 mm
Repeat accuracy	≤ 0.01 % of full scale
Linearity deviation	≤ 0.05 %f.s.
Temperature drift	≤ ± 0.003 % / K
Ambient temperature	-25...+85 °C
Operating voltage	10...30 VDC
Residual ripple	≤ 10 % U _{ss}
Isolation test voltage	≤ 0.5 kV
Short-circuit protection	yes / Cyclic
Wire breakage/Reverse polarity protection	yes / yes (voltage supply)
Output type	Incremental
Resolution, incremental	64 ppr
Pulse frequency max.	200 kHz
Signal level high	min. U _b - 2 V
Signal level low	max. 2.0 V

Functional principle

The measuring principle of inductive angle sensors is based on oscillation circuit coupling between the positioning element and the sensor, whereby an output signal is provided proportional to the angle of the positioning element. The rugged sensors are wear and maintenance-free, thanks to the contactless operating principle. They convince through their excellent repeatability, resolution and linearity within a broad temperature range. The innovative technology ensures a high immunity to electromagnetic DC and AC fields.

Technical data

Output function	8-pin, Push-Pull/HTL
Sample rate	1000 Hz
Current consumption	< 100 mA
Design	QR24
Dimensions	81 x 78 x 24 mm
Flange type	Flange without mounting element
Shaft Type	Hollow shaft
Shaft diameter D [mm]	6 6.35 9.525 10 12 12.7 14 15.875 19.05 20
Housing material	Metal/plastic, ZnAlCu1/PBT-GF30-V0
Electrical connection	Connector, M12 × 1
Vibration resistance	55 Hz (1 mm)
Vibration resistance (EN 60068-2-6)	20 g; 10...3000 Hz; 50 cycles; 3 axes
Shock resistance (EN 60068-2-27)	100 g; 11 ms ½ sinus; each 3x; 3 axes
Continuous shock resistance (EN 60068-2-29)	40 g; 6 ms ½ sinus; each 4000 x; 3 axes
Protection class	IP68 / IP69K
MTTF	138 years acc. to SN 29500 (Ed. 99) 40 °C
Power-on indication	LED, Green
Measuring range display	LED, yellow, yellow flashing

Mounting instructions

Mounting instructions/Description

A

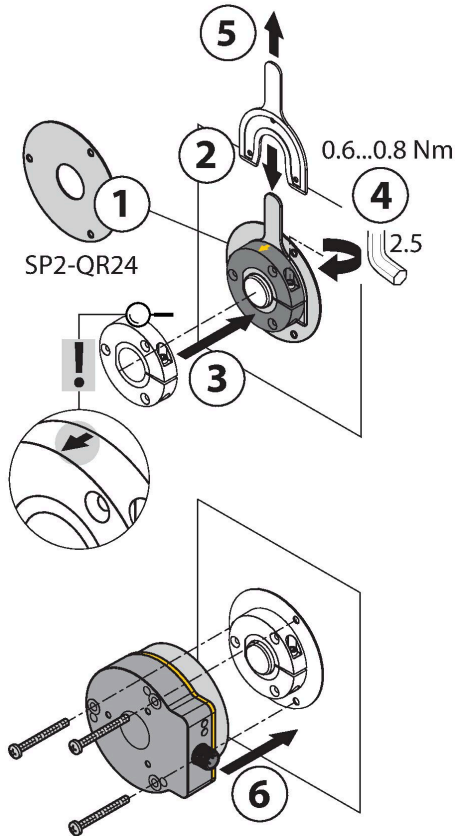

B

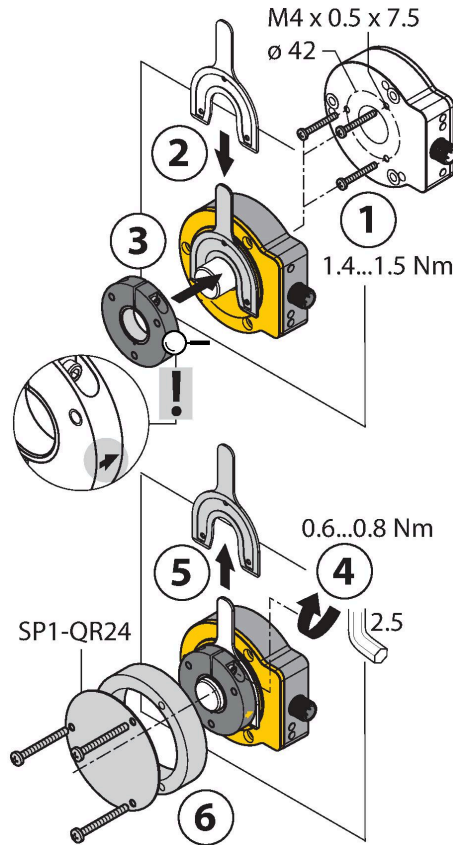

Extensive range of mounting accessories for easy adaptation to many different shaft diameters. Based on the functional principle of RLC coupling, the sensor operates absolutely wear-free and is immune to magnetized metal splinters and other interference fields. Wrong installation is hardly possible.

The adjacent figure shows the two separate units, sensor and positioning element.

Mounting option A:

First, interconnect positioning element and rotatable shaft. Then place the encoder above the rotating part in such a way that you get a tight and protected unit.

Mounting option B:

Push the encoder on the back side of the shaft and fasten it to the machine. Then clamp the positioning element to the shaft with the bracket.

Mounting option C:

If the positioning element is to be screwed on a rotating machine part, use the RA0-QR24 plug which is included in the delivery. Then tie up the bracket. Screw on the encoder via the three bores.

The separately arranged sensor and positioning element inhibit that compensating currents or damaging mechanical loads are transmitted via the shaft to the sensor. In addition, the encoder remains tight and highly protected during its entire lifespan.

The accessories enclosed in the delivery help to mount encoder and positioning element at an optimal distance from each other. LEDs indicate the switching status.

Status display via LED

green steady:

Optimal sensor supply

yellow steady:

Positioning element has reached the end of the measuring range. This is indicated by a lower signal quality.

yellow flashing:

Positioning element is outside the measuring range.

off:

Positioning element is in the measuring range.

C

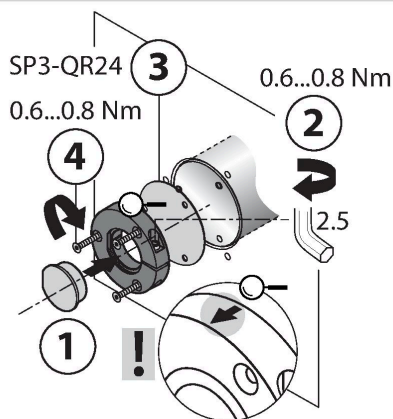

Default: 0°

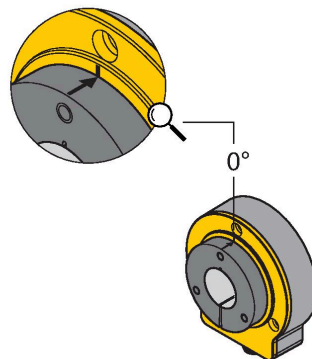

Individual Parameterization (Teaching with Positioning Element)

Jumper between teach input Pin 8	Gnd Pin 1	Ub Pin 2	LED
2 s	Z-track zero point teaching	One-time triggering of burst function	Status LED flashes then turns steady after 2 s
10 s	CCW rotation direction	CW rotation direction	After 10 s status LED flashes fast for 2 s
15 s	-	Factory setting (z-track, CW)	After 15 s power and status LED alternate

To avoid unintended teaching, keep pin 8 potential-free.

Accessories

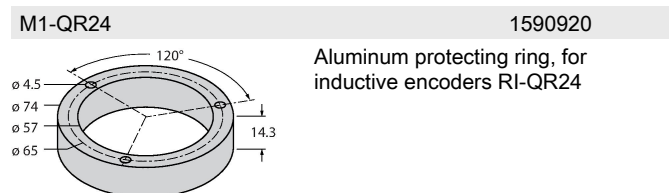
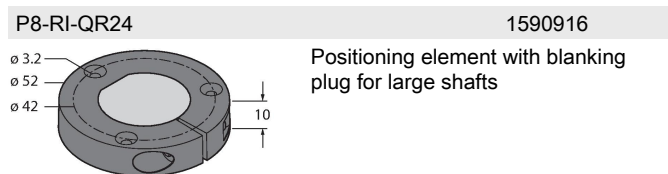
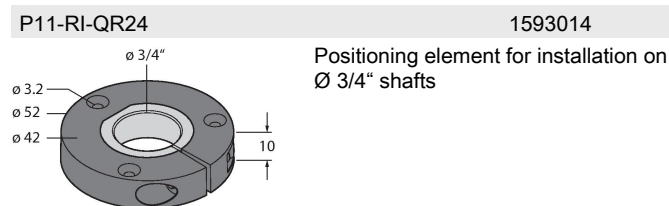
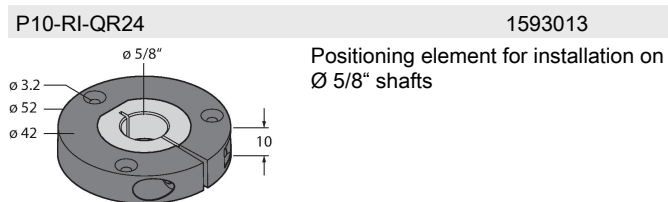
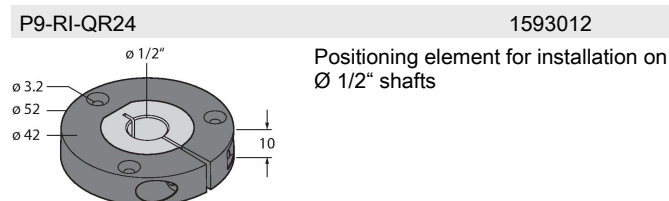
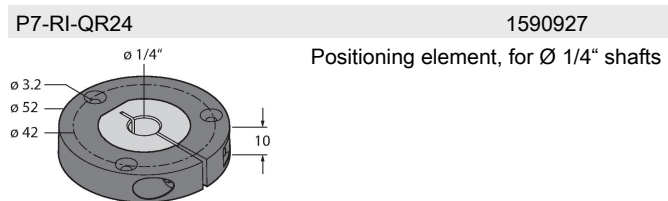
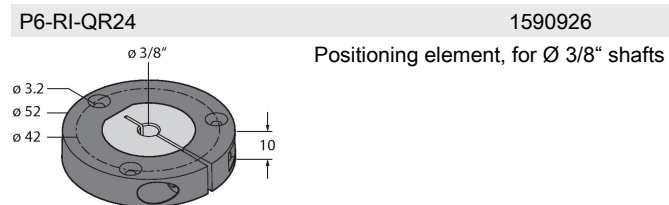
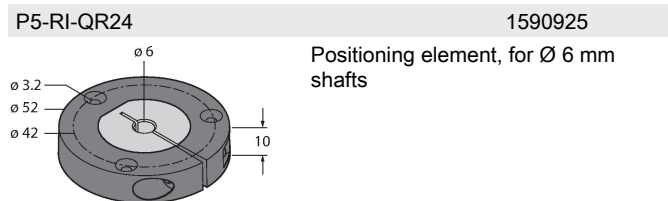
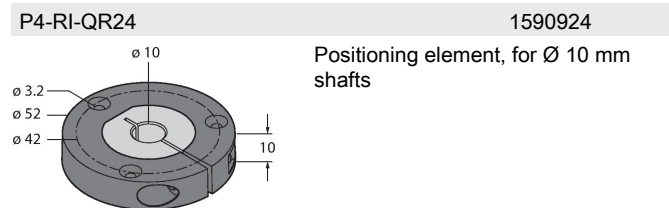
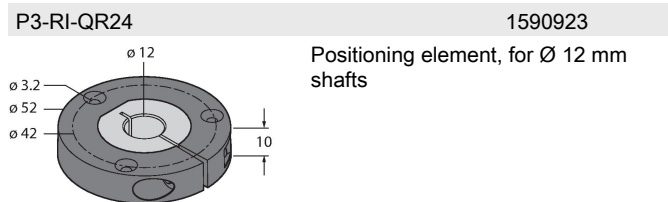
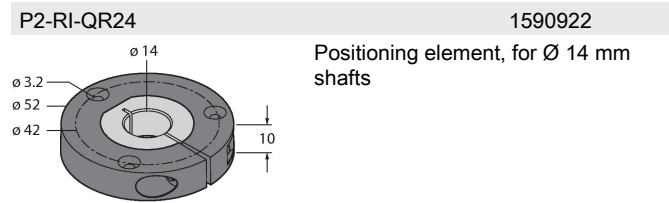
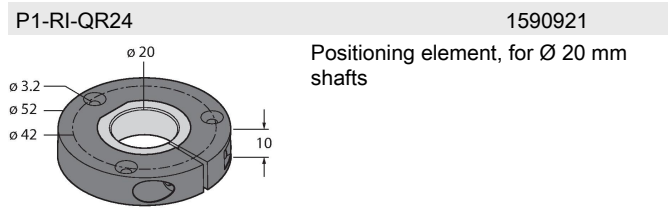

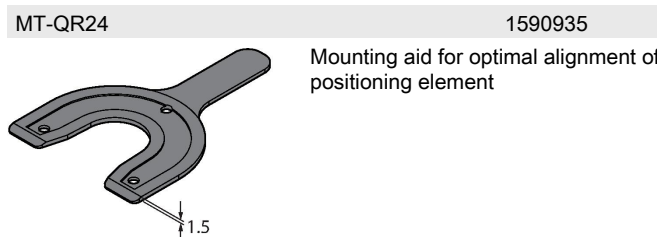
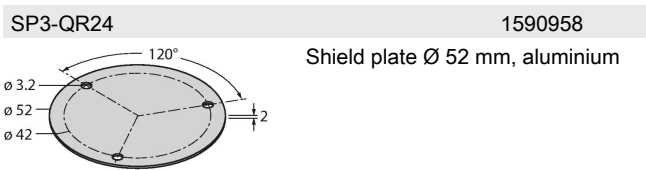
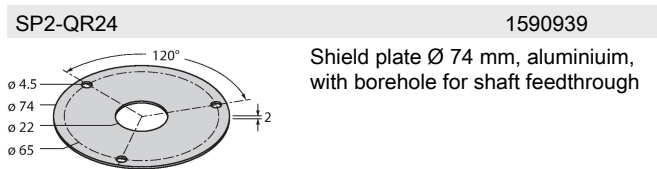
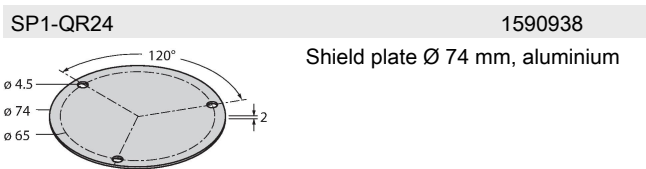
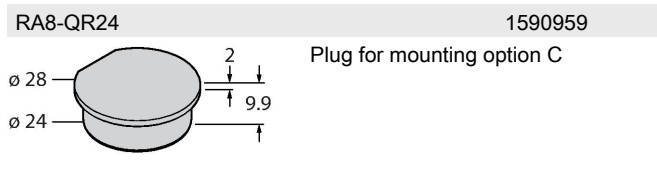
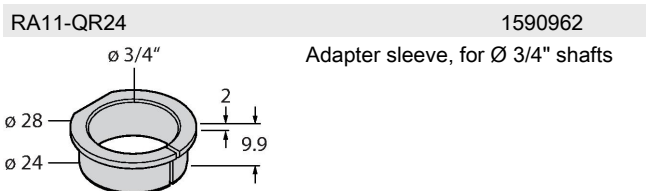
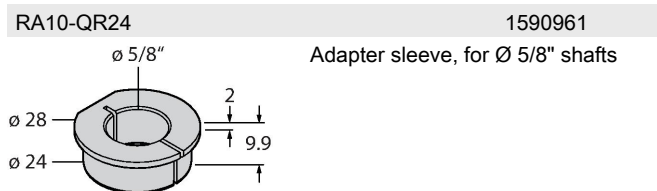
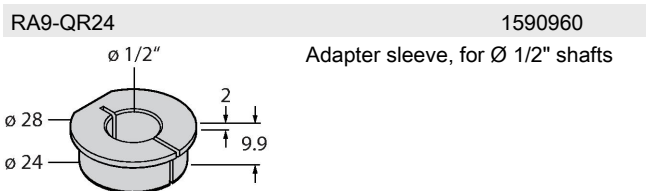
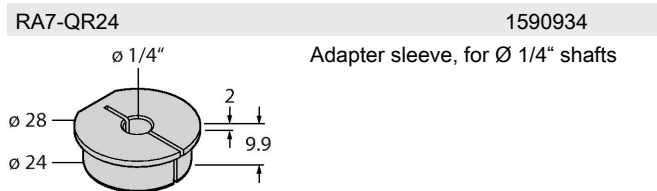
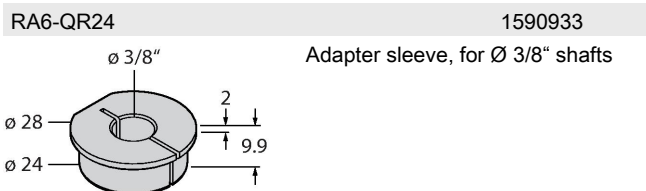
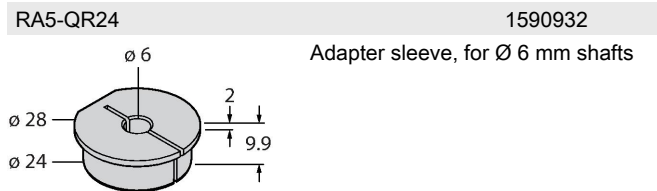
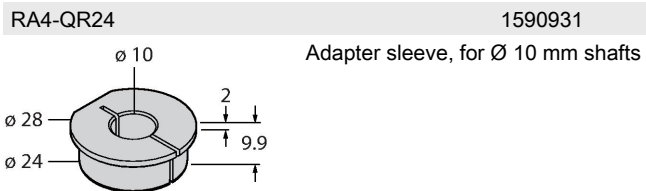
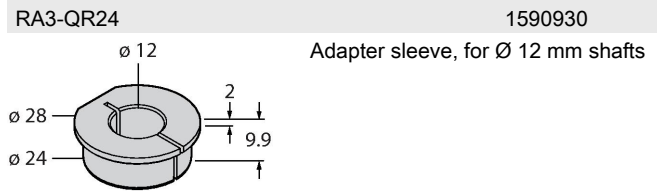
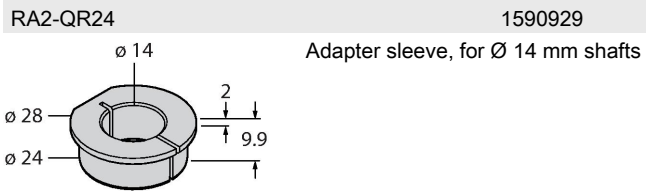
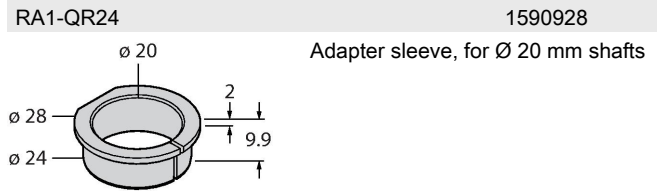
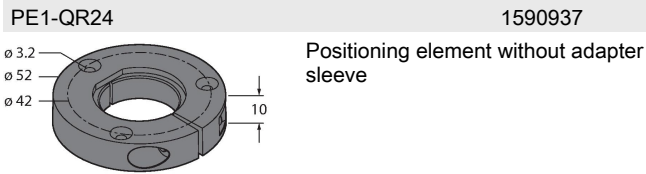

Wiring accessories

Dimension drawing	Type	Ident. no.	
	RKC8T-2/TXL	6625142	Connection cable, female M12, straight, 8-pin, cable length: 2 m, sheath material: PUR, black; cULus approval; other cable lengths and qualities available, see www.turck.com
	E-RKC 8T-264-2	U-04781	Connection cable, female M12, straight, 8-pin (twisted pairs), shielded, cable length: 2 m, sheath material: PVC, black; cULus approval; other cable lengths and qualities available, see www.turck.com