

BI4U-M12-VP6X-H1141 L80

Inductive Sensor

Features

- M12 × 1 threaded barrel
- Chrome-plated brass
- Factor 1 for all metals
- Protection class IP68
- Resistant to magnetic fields
- Large switching distance
- Recessed mountable
- DC 4-wire, 10...30 VDC
- Changeover contact, PNP output
- M12 x 1 male connector

Wiring diagram

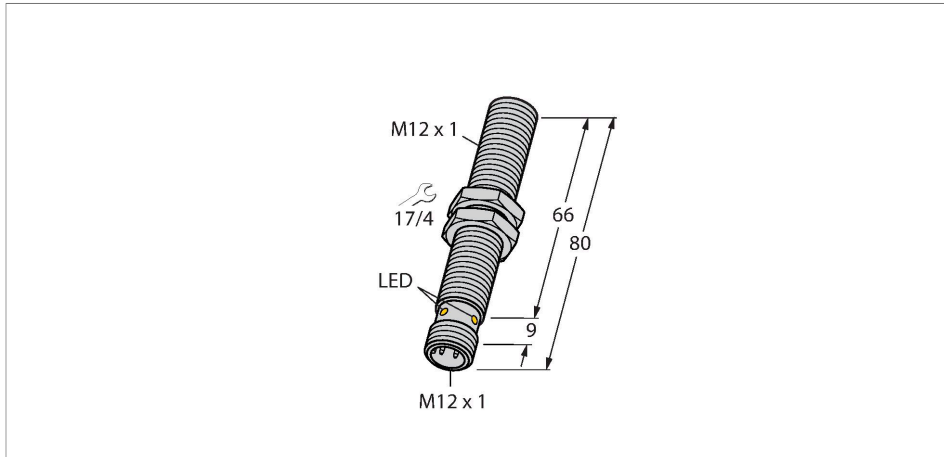

Technical data

Type	BI4U-M12-VP6X-H1141 L80
Ident. no.	100000637
Rated switching distance	4 mm
Mounting conditions	Flush
Secured operating distance	$\leq (0.81 \times S_n)$ mm
Repeat accuracy	$\leq 2\%$ of full scale
Temperature drift	$\leq \pm 10\%$
	$\leq \pm 15\%$, $\leq -25\text{ °C}$ v $\geq +70\text{ °C}$
Hysteresis	3...15 %
Ambient temperature	-30...+85 °C
Operating voltage	10...30 VDC
Residual ripple	$\leq 10\% U_{ss}$
DC rated operational current	$\leq 200\text{ mA}$
No-load current	$\leq 15\text{ mA}$
Residual current	$\leq 0.1\text{ mA}$
Isolation test voltage	$\leq 0.5\text{ kV}$
Short-circuit protection	yes / Cyclic
Voltage drop at I_o	$\leq 1.8\text{ V}$
Wire breakage/Reverse polarity protection	yes / Complete
Output function	4-wire, Complementary contact, PNP
Switching frequency	2 kHz
Design	Threaded barrel, M12 × 1
Dimensions	80 mm
Housing material	Metal, CuZn, Chrome-plated

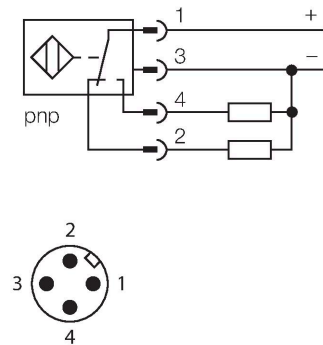

Functional principle

Inductive sensors are designed for wear-free and contactless detection of metal objects. uprox+ sensors have significant advantages due to their patented multi-coil system. They excel thanks to their optimum switching distances, maximum flexibility and operational reliability as well as efficient standardization.

Technical data

Active area material	Plastic, LCP
Max. tightening torque of housing nut	10 Nm
Electrical connection	Connector, M12 × 1
Vibration resistance	55 Hz (1 mm)
Shock resistance	30 g (11 ms)
Protection class	IP68
MTTF	874 years acc. to SN 29500 (Ed. 99) 40 °C
Switching state	LED, Yellow

Mounting instructions

Mounting instructions/Description

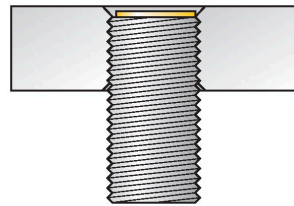
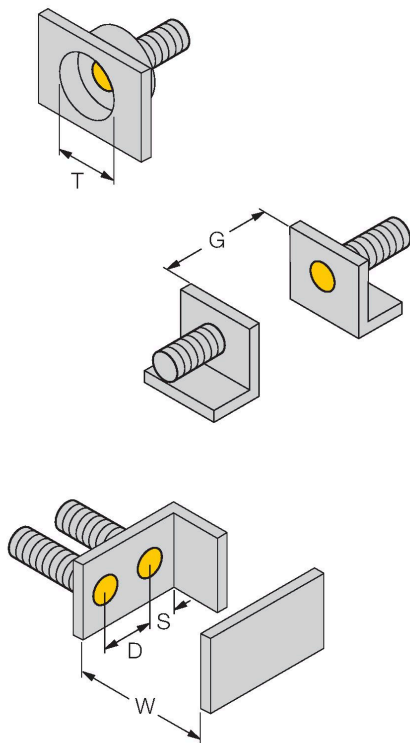

Distance D	24 mm
Distance W	12 mm
Distance T	36 mm
Distance S	18 mm
Distance G	24 mm
Diameter active area B	Ø 12 mm

All flush mountable uprox+ threaded barrel types are also recessed mountable. Safe operation is ensured if the sensor is screwed in by half a turn.

Accessories

QM-12 6945101

Quick-mount bracket with dead-stop; material: Chrome-plated brass. Male thread M16 × 1. Note: The switching distance of the proximity switches may change when using quick-mount brackets.

BST-12B 6947212

Mounting clamp for threaded barrel sensors, with dead-stop; material: PA6

MW-12 6945003

Mounting bracket for threaded barrel sensors; material: Stainless steel A2 1.4301 (AISI 304)

BSS-12 6901321

Mounting clamp for smooth and threaded barrel sensors; material: Polypropylene

PN-M12 6905309

Impact protection nut for M12x1 threaded barrel devices; material: Stainless steel A2 1.4305 (AISI 303)