

FCI-D09A4-NA-H1141/M16

Flow Monitoring – Inline Sensor with Separate Processor

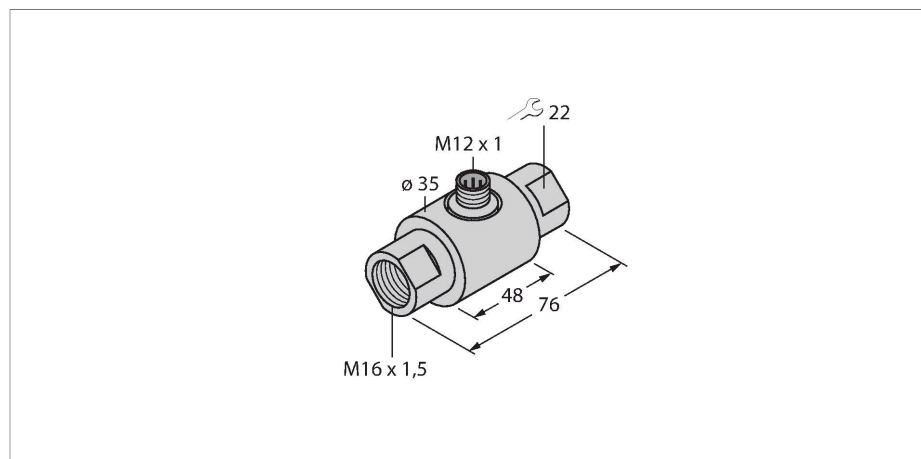

Features

- Flow sensor for liquid media
- Calorimetric principle
- Adjustment via potentiometer on processor
- Status indicated via LED chain on signal processor
- Connector device, M12 × 1
- 4-wire connection to the processor

Wiring diagram

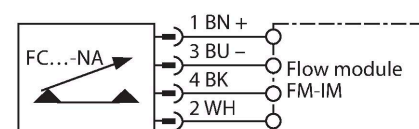

Technical data

Ident. no.	6870631
Type	FCI-D09A4-NA-H1141/M16
Mounting	Inline sensor
Flow operating range	0,03...0,9 l/min
Stand-by time	typ. 8 s (2...15 s)
Switch-on time	typ. 2 s (1...15 s)
Switch-off time	typ. 2 s (1...15 s)
Temperature jump, response time	max. 12 s
Temperature gradient	≤ 250 K/min
Medium temperature	-20...+80 °C
Ambient temperature	-20...+70 °C
Protection class	IP67
Design	Inline
Housing material	Stainless steel, V4A (1.4571)
Sensor material	Stainless steel, V4A (1.4571)
Electrical connection	Connector, M12 × 1
Process Pressure	16 bar
Process connection	M16 × 1.5

Functional principle

The function of the inline flow sensors is based on the thermo-dynamic principle. Heat is generated in a measuring tube and absorbed by the flowing medium. The transported heat loss is thus a measure of the flow speed. Thus TURCK's wear-free flow sensors reliably monitor the flow of gaseous and liquid media. A low pressure drop and fast response to flow rate variations are the outstanding features of these devices.