

**Ultrasonic Sensor**  
**Diffuse Mode Sensor**  
**RU100U-M18M-LFX-H1151**

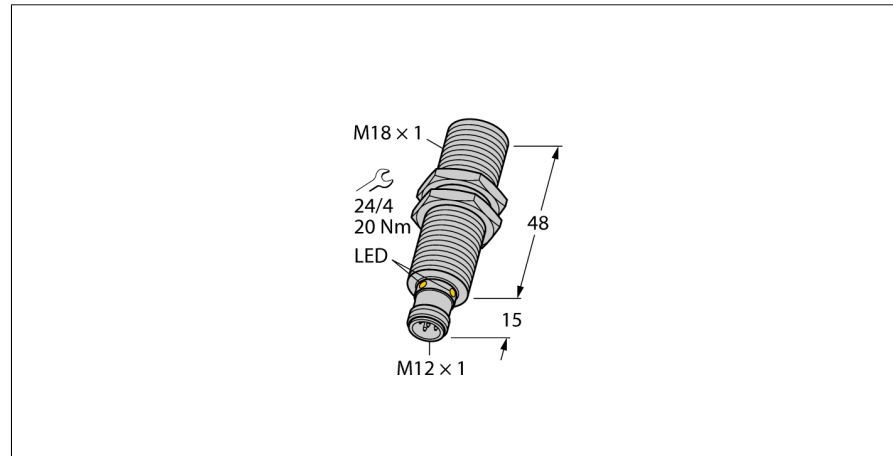

- Smooth sonic transducer face
- Cylindrical housing M18, potted
- Connection via M12 x 1 male
- Temperature compensation
- Blind zone: 15 cm
- Range: 100 cm
- Resolution: 1 mm
- Sonic cone angle: 16°
- Frequency output 300...2000 Hz (150...1000 Hz)
- Frequency range selectable via FS control line (see functional principle)

|                                      |                                   |
|--------------------------------------|-----------------------------------|
| <b>Type designation</b>              | RU100U-M18M-LFX-H1151             |
| Ident-No.                            | 1610022                           |
| <b>Function</b>                      | Ultrasonic diffuse mode sensor    |
| Range                                | 150...1000 mm                     |
| Resolution                           | 1 mm                              |
| minimum measuring range              | 100 mm                            |
| minimum switching range              | 10 mm                             |
| Ultrasound frequency                 | 200 kHz                           |
| Repeat accuracy                      | 0.15 % of full scale              |
| Temperature drift                    | 1.5% of full scale                |
| Linearity error                      | ≤ ± 0.5 %                         |
| Edge lengths of the nominal actuator | 100 mm                            |
| Approach speed                       | ≤ 8 m/s                           |
| Pass speed                           | ≤ 2 m/s                           |
| <b>Operating voltage</b>             | 15...30 VDC                       |
| Residual ripple                      | 10 % U <sub>in</sub>              |
| DC rated operational current         | ≤ 150 mA                          |
| Residual current                     | ≤ 0.1 mA                          |
| Response time typical                | 90 ms                             |
| Readiness delay                      | 300 ms                            |
| Switching frequency                  | 6.9 Hz                            |
| Short-circuit protection             | yes/ Cyclic                       |
| Reverse polarity protection          | yes                               |
| Wire breakage protection             | yes                               |
| <b>Design</b>                        | Threaded barrel, M18              |
| Radiation direction                  | straight                          |
| Dimensions                           | 63 x Ø 18 mm                      |
| Housing material                     | Metal, CuZn, Nickel-plated        |
| Transducer material                  | Plastic, Epoxyd resin and PU foam |
| Electrical connection                | Connector, M12 x 1, 5-wire        |
| Protection class                     | IP67                              |
| Ambient temperature                  | -25...+70 °C                      |
| Storage temperature                  | -40...+80 °C                      |
| Declaration of conformity EN ISO/IEC | EN 60947-5-7                      |
| Vibration resistance                 | IEC 60068-2                       |
| MTTF                                 | 281 years                         |
| MTTF note                            | acc. to SN 29500 (Ed. 99) 40 °C   |

|                        |             |
|------------------------|-------------|
| <b>Switching state</b> | LED, Yellow |
| Object detected        | LED, Green  |

**Wiring Diagram**

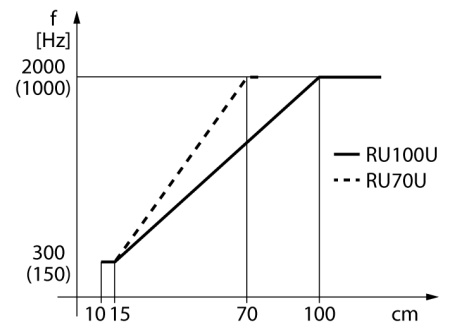
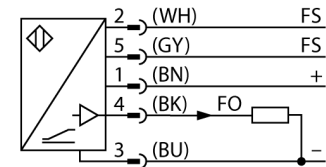

**Functional principle**

Ultrasonic sensors capture a multitude of objects contactless and wear-free with ultrasonic waves. It does not matter whether the object is transparent or opaque, metallic or non-metallic, firm, liquid or powdery. Even environmental conditions such as spray, dust or rain hardly affect their function.

The frequency range can be selected via the control input. If this is connected to ground (-), the lower frequency range is selected. If it is not connected to ground or connected to the supply voltage, the output works in the higher frequency range.

**Sonic Cone**

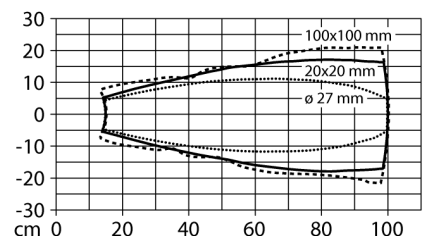

**Ultrasonic Sensor  
Diffuse Mode Sensor  
RU100U-M18M-LFX-H1151**

Mounting instructions/Description

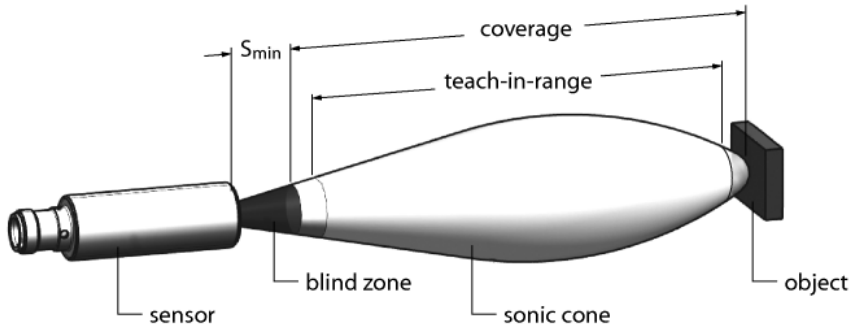

# Ultrasonic Sensor

## Diffuse Mode Sensor

### RU100U-M18M-LFX-H1151

#### Accessories

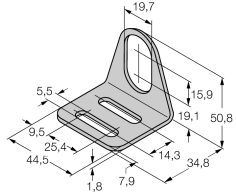
| Type code | Ident-No. | Description  | Dimension drawing   |
|-----------|-----------|--|---|
| MW-18     | 6945004   | Mounting bracket for threaded barrel sensors; material: Stainless steel A2 1.4301 (AISI 304) |  |

#### Function accessories

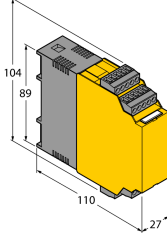
| Type code     | Ident-No. | Description   | Dimension drawing  |
|---------------|-----------|---|--|
| IM21-14-CDTRI | 7505650   | Rotation speed monitor with display indication, freely parametrizable monitoring functions, start-up bypass, interlock function, pulse output, current output |  |