

TP-206A-CF-H1141-L050

Temperature Detection – Probe

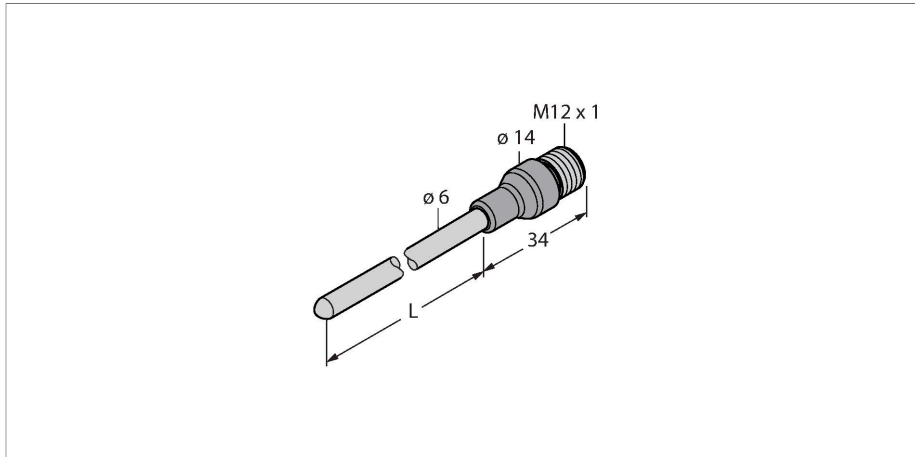

Technical data

Type	TP-206A-CF-H1141-L050
Ident. no.	9910646
Temperature range	
Measuring range	-50...120 °C
Temperature operating range	-58...248 °F
Accuracy	0.15 °C + 0.002 • t (-30 ...350 °C)
Self-heating	0.4 K/mW at 0 °C
Measuring element	Pt-100 probe, DIN EN 60751, class A
Response time	t 0.5 = 6 s / t 0.9 = 15 s in water at 0.2 m/s
Immersion depth (L)	50 mm
Protection type and class	IP67
Output function	4-wire
Ambient conditions	
Ambient temperature	-40...+120 °C
Storage temperature	-40...+85 °C
Housing	
Housing material	Stainless steel, 1.4404 (AISI 316L)
Sensor material	Stainless steel, 1.4404 (AISI 316L)
Process connection	For compression fittings, thermowell or direct mounting
Process Pressure	100 bar
Electrical connection	Connector, M12 × 1

Features

- Pt-100 probe acc. to DIN EN 60751
- Vibration and shock-resistant
- Connectable to TS, TTM, IM34, BL20, BL67
- Max. temperature connector: 120°C
- 4-wire connection technology

Wiring diagram

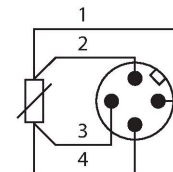

Functional principle

Resistance thermometers are used for the detection and monitoring of temperatures to optimize and control a process. Typical applications are in machine and plant construction as well as in the process industry. The core element of the temperature probe is a temperature-dependent resistor.

Technical data

Reference conditions acc. to IEC 61298-1

Temperature	15...+25 °C
Atmospheric pressure	860...1060 hPa abs.
Humidity	45...75 % rel.
Auxiliary power	24 VDC
MTTF	2283 years acc. to SN 29500 (Ed. 99) 20 °C