

# TTM-206A-CF-LIUPN-H1140-L200

## Temperature Detection – With Current Output and PNP/NPN Transistor Switching Output

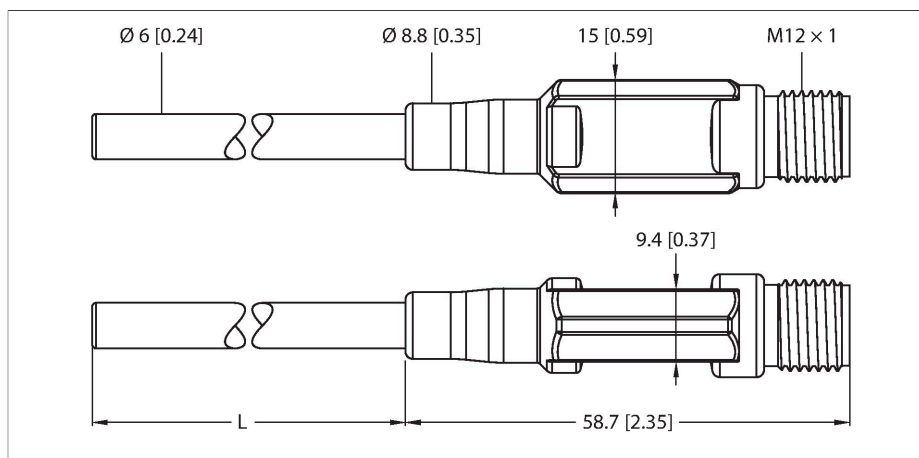

### Features

- Miniature design
- Factory setting 0...150 °C
- Parameterizable via IO-Link
- Analog output 4...20 mA (2-wire)
- Switching output
- Compression fitting process connection
- Bendable probe (min. bending radius: 3x outer diameter; excluding 30-mm probe tip)

### Wiring diagram

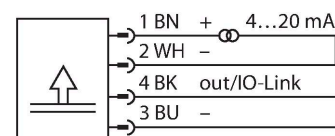

### Functional principle

The TTM miniature transmitters are available with integrated probe. Due to the integrated electronics, the limited temperature range must be observed, especially in the area of the M12 connector.

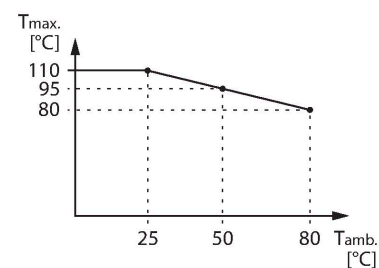

### Technical data

Type	TTM-206A-CF-LIUPN-H1140-L200
Ident. no.	9910670
<b>Temperature range</b>	
Measuring range	-210...650 °C
Temperature operating range	-346...1202 °F
Factory setting	0...150 °C
	32...302 °F
Note	Max. temperature of electronics: 80 °C/176 °F
Accuracy	0.15 °C + 0.002 •  t  (-30 ...350 °C)
Measuring element	Pt-100 probe, DIN EN 60751, class A
Response time	t 0.5 = 6 s / t 0.9 = 15 s in water at 0.2 m/s
Immersion depth (L)	200 mm
<b>Power supply</b>	
Operating voltage	15...30 VDC
Current consumption	≤ 20 mA
Voltage drop at I <sub>o</sub>	≤ 2 V
Short-circuit/reverse polarity protection	yes / yes
Protection type and class	IP67 / III
<b>Outputs</b>	
Output 1	Switching output or IO-Link mode
Output 2	analog output

## Technical data

Switching output	
Communication protocol	IO-Link
Output function	NO/NC programmable, PNP/NPN
Switching point accuracy	± 0.3 K
Rated operational current	0.15 A
Switching cycles	≥ 100 mil.
Release position	-210...+640 °C
Switching point	-200...+650 °C
Analog output	
Current output	4...20 mA
Load	≤ [(Vsupply - 10 V)/21 mA] kΩ
Accuracy (Lin. + Hys. + Rep.)	± 0.3 K
Remark	0.1 % of full scale applies to temperatures > +300 °C
Repeatability	0.1 K
IO-Link	
IO-Link specification	Specified acc. to version 1.1
Programming	FDT / DTM
Transmission physics	corresponds to 3-wire physics (PHY2)
Transmission rate	COM 2 / 38.4 kbps
Process data width	16 bit
Measured value information	15 bit
Switchpoint information	1 bit
Frame type	2.2
Genauigkeit	± 0.2 K
Included in the SIDI GSDML	Yes
Temperature behaviour	
Temperature coefficient zero point Tk0	± 0.1 % of full scale/10 K
Temperature coefficient span T <sub>KS</sub>	± 0.1 % of full scale/10 K
Ambient conditions	
Ambient temperature	-40...+80 °C
Storage temperature	-40...+80 °C
Housing	
Housing material	Stainless-steel/Plastic, 1.4404 (AISI 316L)
Sensor material	Stainless steel, 1.4404 (AISI 316L)
Process connection	For compression fittings, thermowell or direct mounting
Process Pressure	100 bar

## Technical data

Electrical connection	Connector, M12 × 1
Reference conditions acc. to IEC 61298-1	
Temperature	15...+25 °C
Atmospheric pressure	860...1060 hPa abs.
Humidity	45...75 % rel.
Auxiliary power	24 VDC
MTTF	541 years acc. to SN 29500 (Ed. 99) 40 °C