

DRM270110LT**Weidmüller Interface GmbH & Co. KG**

Klingenbergstraße 26

D-32758 Detmold

Germany

www.weidmueller.com

Product image

Similar to illustration

Individual relays within the D-SERIES DRM

- 2 CO contacts
- AC coils
- With integrated status LED and test button

General ordering data

Version	D-SERIES DRM, Relay, Number of contacts: 2, CO contact, AgNi flash gold-plated, Rated control voltage: 110 V DC, Continuous current: 10 A, Plug-in connection
Order No.	7760056071
Type	DRM270110LT
GTIN (EAN)	4032248855841
Qty.	20 pc(s).

Creation date March 29, 2021 8:43:58 PM CEST

Catalogue status 12.03.2021 / We reserve the right to make technical changes.

DRM270110LT

Weidmüller Interface GmbH & Co. KG

Klingenbergstraße 26

D-32758 Detmold

Germany

www.weidmueller.com

Technical data

Dimensions and weights

Depth	35.7 mm	Depth (inches)	1.406 inch
Height	27.4 mm	Height (inches)	1.079 inch
Net weight	34.15 g	Width	21 mm
Width (inches)	0.827 inch		

Temperatures

Storage temperature	-40 °C...70 °C	Operating temperature	-40 °C...60 °C
Humidity	35...85 % rel. humidity, no condensation		

Environmental Product Compliance

REACH SVHC	Lead 7439-92-1
------------	----------------

Rated data UL

Certificate No. (cURus)	E312083
-------------------------	---------

Control side

Coil resistance	11000 $\Omega \pm 10\%$	Power rating	1.2 W
Pull-in/drop-out voltage, typ.	82.5 V / 11 V DC	Rated control voltage	110 V DC
Rated current DC	10 mA	Status indicator	Green LED

Load side

AC switching capacity (resistive), max.	2500 VA	Continuous current	10 A
DC switching capacity (resistive), max.	240 W @ 24 V	Inrush current	20 A / 50 ms
Max. switching frequency at rated load	0.1 Hz	Min. switching power	10 mA @ 12 V, 100 mA @ 5 V
Rated switching voltage	250 V AC	Switch-off delay	≤ 20 ms
Switch-on delay	≤ 20 ms		

Contact data

Contact type	2 CO contact (AgNi flash gold-plated)	Contact resistance	≤ 50 m Ω
Mechanical service life	20 x 10 ⁶ switching cycles		

General data

Test button	yes (lockable)		
Mechanical switch position indicator	Yes		
Colour	Transparent		
UL94 flammability rating component	Component	Relay cover	
	UL94 flammability rating	V-2	
	Component	Relay baseplate	
	UL94 flammability rating	V-0	
	Component	Relay status indicator	
	UL94 flammability rating	HB	
	Component	Relay test button	
	UL94 flammability rating	HB	

Creation date March 29, 2021 8:43:58 PM CEST

Catalogue status 12.03.2021 / We reserve the right to make technical changes.

2

DRM270110LT

Weidmüller Interface GmbH & Co. KG

Klingenbergstraße 26

D-32758 Detmold

Germany

www.weidmueller.com

Technical data

Insulation coordination

Creepage and clearance distance input – output	≥ 5.5 mm	Dielectric strength of neighbouring contacts	1 kV _{eff} / 1 min
Dielectric strength of open contact	1 kV _{eff} / 1 min	Dielectric strength, Input/Output	1.8 kV _{eff} / 1 min.
Impulse withstand voltage	6 kV (1.2/50 μs)	Pollution severity	2
Protection degree	IP20	Rated voltage	250 V
Surge voltage category	III		

Further details of approvals / standards

Standards	IEC 61810-1, EN 60664-1:2007, EN 61000-6-2:2005, EN 61000-6-4:2007 + A1:2011, UL 508	Certificate No. (cURus)	E312083
-----------	--	-------------------------	---------

Connection data

Wire connection method	Plug-in connection
------------------------	--------------------

Classifications

ETIM 6.0	EC001437	ETIM 7.0	EC001437
ECLASS 9.0	27-37-16-01	ECLASS 9.1	27-37-16-01
ECLASS 10.0	27-37-16-01	ECLASS 11.0	27-37-16-01

Approvals

Approvals



ROHS	Conform
UL File Number Search	E312083

Downloads

Approval/Certificate/Document of Conformity	EU Konformitätserklärung / EU Declaration of Conformity
Engineering Data	STEP
Engineering Data	EPLAN, WSCAD

DRM270110LT

Weidmüller Interface GmbH & Co. KG
 Klingenbergstraße 26
 D-32758 Detmold
 Germany

www.weidmueller.com

Drawings

Wiring diagram

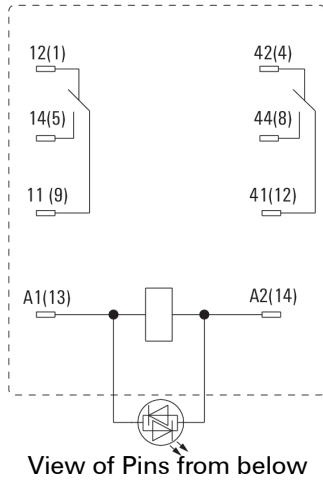

Graph

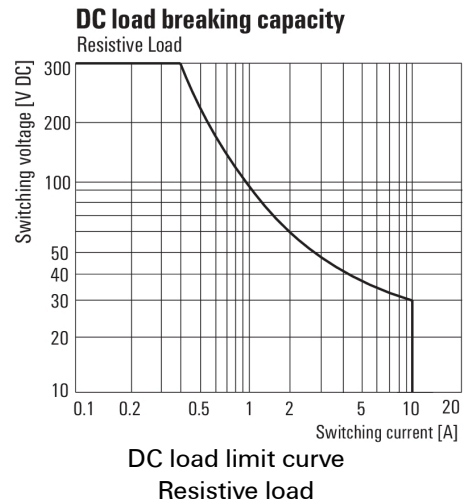

Graph

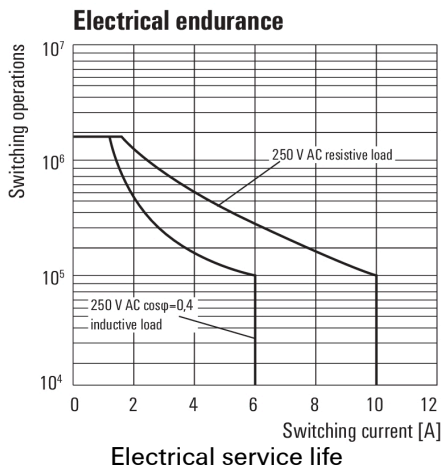

Graph

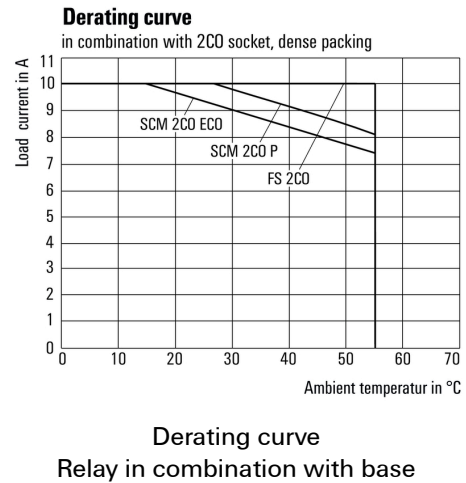

Graph

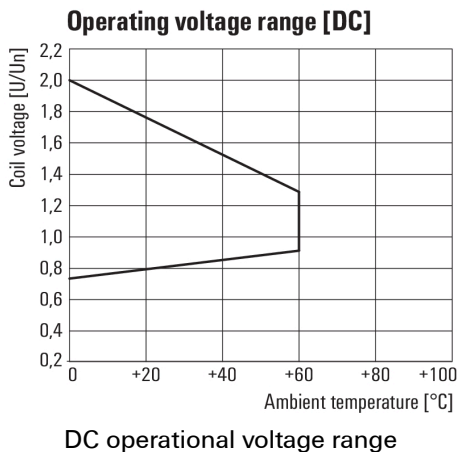

Dimensional drawing

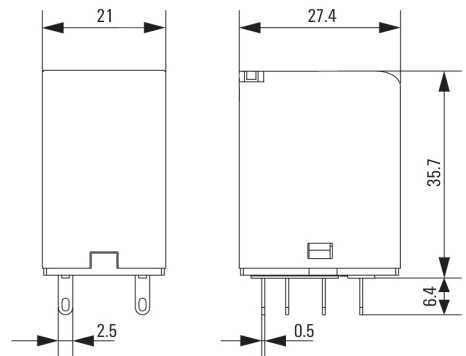

Data sheet

DRM270110LT

Weidmüller Interface GmbH & Co. KG
 Klingenbergstraße 26
 D-32758 Detmold
 Germany

www.weidmueller.com

Drawings

Miscellaneous

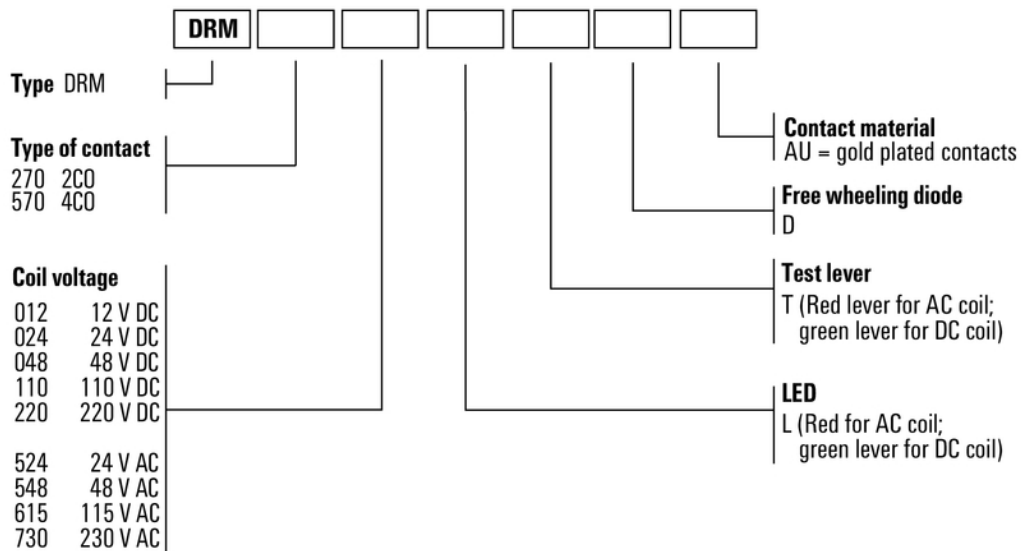

Type codes