

LUF 15.00/03/90V 5.0SN BK BX

Weidmüller Interface GmbH & Co. KG
 Klingenbergstraße 26
 D-32758 Detmold
 Germany

www.weidmueller.com

Product image

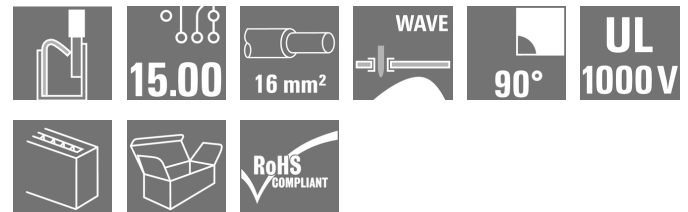

The sturdy, direct connection for extreme current and voltage requirements in all power electronics applications such as solar inverters, frequency converters, servo-controllers and power supplies.

General ordering data

| | |
|--------------|--|
| Version | Printed circuit board terminals, 15.00 mm, Number of poles: 3, 90°, Solder pin length (l): 5 mm, black, PUSH IN with actuator, Clamping range, max. : 16 mm ² , Box |
| Order No. | 2492010000 |
| Type | LUF 15.00/03/90V 5.0SN BK BX |
| GTIN (EAN) | 4050118604283 |
| Qty. | 30 pc(s). |
| Product data | IEC: 1000 V / 101 A / 0.5 - 25 mm ² UL: 600 V / 58 A / AWG 18 - AWG 6 |
| Packaging | Box |

Creation date April 15, 2021 10:26:57 PM CEST

LUF 15.00/03/90V 5.0SN BK BX**Weidmüller Interface GmbH & Co. KG**

Klingenbergstraße 26

D-32758 Detmold

Germany

www.weidmueller.com

Technical data**Dimensions and weights**

| | | | |
|--------------------------|----------|-----------------|------------|
| Depth | 26.45 mm | Depth (inches) | 1.041 inch |
| Height | 47.03 mm | Height (inches) | 1.852 inch |
| Height of lowest version | 42.03 mm | Net weight | 36.28 g |
| Width | 41.58 mm | Width (inches) | 1.637 inch |

System parameters

| | | | |
|--|------------------------------|--|---|
| Product family | OMNIMATE Power - series LU | Wire connection method | PUSH IN with actuator |
| Mounting onto the PCB | THT solder connection | Conductor outlet direction | 90° |
| Pitch in mm (P) | 15 mm | Pitch in inches (P) | 0.591 inch |
| Number of poles | 3 | Pin series quantity | 1 |
| Fitted by customer | No | Solder pin length (l) | 5 mm |
| Solder pin dimensions | d = 1.2 mm, Octagonal | Solder eyelet hole diameter (D) | 1.7 mm |
| Solder eyelet hole diameter tolerance (D)+ | 0,1 mm | Number of solder pins per pole | 2 |
| Screwdriver blade | 0.8 x 4.0 | Stripping length | 18 mm |
| L1 in mm | 30 mm | L1 in inches | 1.181 inch |
| Touch-safe protection acc. to DIN VDE 0470 | IP20 plugged/ IP10 unplugged | Touch-safe protection acc. to DIN VDE 57 106 | touch-safe with connected connectors from 6 mm ² |

Material data

| | | | |
|----------------------------------|------------|-----------------------------|--------|
| Insulating material | Wemid (PA) | Colour | black |
| Colour chart (similar) | RAL 9011 | Insulating material group | I |
| Comparative Tracking Index (CTI) | ≥ 600 | UL 94 flammability rating | V-0 |
| Contact material | E-Cu | Storage temperature, min. | -40 °C |
| Storage temperature, max. | 70 °C | Operating temperature, min. | -40 °C |
| Operating temperature, max. | 120 °C | | |

Conductors suitable for connection

| | |
|---|---------------------|
| Clamping range, min. | 0.5 mm ² |
| Clamping range, max. | 16 mm ² |
| Wire connection cross section AWG, min. | AWG 18 |
| Wire connection cross section AWG, max. | AWG 4 |
| Solid, min. H05(07) V-U | 0.5 mm ² |
| Solid, max. H05(07) V-U | 16 mm ² |
| Stranded, min. H07V-R | 10 mm ² |
| Stranded, max. H07V-R | 25 mm ² |
| Flexible, min. H05(07) V-K | 0.5 mm ² |
| Flexible, max. H05(07) V-K | 25 mm ² |
| w. plastic collar ferrule, DIN 46228 pt 4, 0.5 mm ² min. | |
| w. plastic collar ferrule, DIN 46228 pt 4, 16 mm ² max. | |
| w. wire end ferrule, DIN 46228 pt 1, min. | 0.5 mm ² |
| w. wire end ferrule, DIN 46228 pt 1, max. | 16 mm ² |

LUF 15.00/03/90V 5.0SN BK BX

Weidmüller Interface GmbH & Co. KG
 Klingenbergstraße 26
 D-32758 Detmold
 Germany

www.weidmueller.com

Technical data

| | | | |
|--|--|------------------------------|-----------------------------|
| Clampable conductor | Cross-section for conductor connection | Type | fine-wired |
| | | nominal | 2.5 mm ² |
| wire end ferrule | | Stripping length | nominal 20 mm |
| | | Recommended wire-end ferrule | H2.5/25D BL |
| | | Stripping length | nominal 18 mm |
| | | Recommended wire-end ferrule | H2.5/18 |
| Cross-section for conductor connection | Type | fine-wired | |
| | nominal | 4 mm ² | |
| wire end ferrule | | Stripping length | nominal 20 mm |
| | | Recommended wire-end ferrule | H4.0/26D GR |
| | | Stripping length | nominal 18 mm |
| | | Recommended wire-end ferrule | H4.0/18 |
| Cross-section for conductor connection | Type | fine-wired | |
| | nominal | 6 mm ² | |
| wire end ferrule | | Stripping length | nominal 20 mm |
| | | Recommended wire-end ferrule | H6.0/26 SW |
| | | Stripping length | nominal 18 mm |
| | | Recommended wire-end ferrule | H6.0/18 |
| Cross-section for conductor connection | Type | fine-wired | |
| | nominal | 10 mm ² | |
| wire end ferrule | | Stripping length | nominal 21 mm |
| | | Recommended wire-end ferrule | H10.0/28 EB |
| | | Stripping length | nominal 18 mm |
| | | Recommended wire-end ferrule | H10.0/18 |
| Cross-section for conductor connection | Type | fine-wired | |
| | nominal | 16 mm ² | |
| wire end ferrule | | Stripping length | nominal 21 mm |
| | | Recommended wire-end ferrule | H16.0/28 GN |
| | | Stripping length | nominal 18 mm |
| | | Recommended wire-end ferrule | H16.0/18 |
| Cross-section for conductor connection | Type | fine-wired | |
| | nominal | 1.5 mm ² | |
| wire end ferrule | | Stripping length | nominal 20 mm |
| | | Recommended wire-end ferrule | H1.5/24 R |
| | | Stripping length | nominal 18 mm |
| | | Recommended wire-end ferrule | H1.5/18 |

Reference text Length of ferrules is to be chosen depending on the product and the rated voltage., The outside diameter of the plastic collar should not be larger than the pitch (P)

LUF 15.00/03/90V 5.0SN BK BX

Weidmüller Interface GmbH & Co. KG

Klingenbergstraße 26

D-32758 Detmold

Germany

www.weidmueller.com

Technical data

Rated data acc. to IEC

| | | | |
|---|---------|---|---------|
| Rated current, min. number of poles (Tu=20°C) | 101 A | Rated current, max. number of poles (Tu=20°C) | 89.7 A |
| Rated current, min. number of poles (Tu=40°C) | 95.3 A | Rated current, max. number of poles (Tu=40°C) | 79.4 A |
| Rated voltage for surge voltage class / pollution degree II/2 | 1,000 V | Rated voltage for surge voltage class / pollution degree III/2 | 1,000 V |
| Rated voltage for surge voltage class / pollution degree III/3 | 1,000 V | Rated impulse voltage for surge voltage class/ pollution degree II/2 | 8 kV |
| Rated impulse voltage for surge voltage class/ pollution degree III/2 | 8 kV | Rated impulse voltage for surge voltage class/ contamination degree III/3 | 8 kV |

Rated data acc. to CSA

| | | | |
|-----------------------------------|--------|-----------------------------------|-------|
| Rated voltage (Use group B / CSA) | 600 V | Rated voltage (Use group C / CSA) | 600 V |
| Rated voltage (Use group D / CSA) | 600 V | Rated current (Use group B / CSA) | 58 A |
| Rated current (Use group C / CSA) | 58 A | Rated current (Use group D / CSA) | 5 A |
| Wire cross-section, AWG, min. | AWG 18 | Wire cross-section, AWG, max. | AWG 6 |

Rated data acc. to UL 1059

| | | | |
|---------------------------------------|---|---------------------------------------|---------|
| Institute (cURus) |  | Certificate No. (cURus) | E60693 |
| Rated voltage (Use group B / UL 1059) | 600 V | Rated voltage (Use group C / UL 1059) | 600 V |
| Rated voltage (Use group D / UL 1059) | 600 V | Rated voltage (Use group E / UL 1059) | 1,000 V |
| Rated current (Use group B / UL 1059) | 58 A | Rated current (Use group C / UL 1059) | 58 A |
| Rated current (Use group D / UL 1059) | 5 A | Rated current (Use group E / UL 1059) | 58 A |
| Wire cross-section, AWG, min. | AWG 18 | Wire cross-section, AWG, max. | AWG 6 |
| Reference to approval values | Specifications are maximum values, details - see approval certificate. | | |

Packing

| | | | |
|-----------|--------|------------|--------|
| Packaging | Box | VPE length | 283 mm |
| VPE width | 165 mm | VPE height | 50 mm |

Classifications

| | | | |
|-------------|-------------|-------------|-------------|
| ETIM 6.0 | EC002643 | ETIM 7.0 | EC002643 |
| ECLASS 9.0 | 27-44-04-01 | ECLASS 9.1 | 27-44-04-01 |
| ECLASS 10.0 | 27-44-04-01 | ECLASS 11.0 | 27-46-01-01 |

LUF 15.00/03/90V 5.0SN BK BX

Weidmüller Interface GmbH & Co. KG
 Klingenbergstraße 26
 D-32758 Detmold
 Germany

www.weidmueller.com

Technical data**Important note**

| | |
|----------------|--|
| IPC conformity | Conformity: The products are developed, manufactured and delivered according international recognized standards and norms and comply with the assured properties in the data sheet resp. fulfill decorative properties in accordance with IPC-A-610 "Class 2". Further claims on the products can be evaluated on request. |
| Notes | <ul style="list-style-type: none"> • Additional colours on request • Rated current related to rated cross-section & min. No. of poles. • Wire end ferrule without plastic collar to DIN 46228/1 • Wire end ferrule with plastic collar to DIN 46228/4 • P on drawing = pitch • Rated data refer only to the component itself. Clearance and creepage distances to other components are to be designed in accordance with the relevant application standards. • The test point can only be used as potential-pickup point. • Long term storage of the product with average temperature of 50 °C and average humidity 70%, 36 months |

Approvals

Approvals



| | |
|-----------------------|---------|
| ROHS | Conform |
| UL File Number Search | E60693 |

Downloads

| | |
|---|---|
| Approval/Certificate/Document of Conformity | Declaration of the Manufacturer |
| Engineering Data | STEP |
| User Documentation | QR-Code product handling video |
| Brochure/Catalogue | Catalogues in PDF-format |

Drawings

Product image

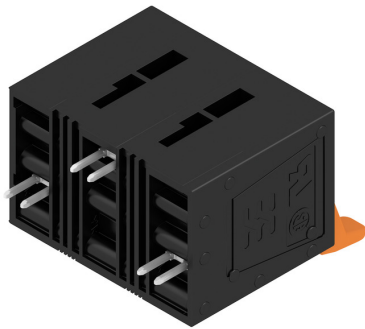

Dimensional drawing

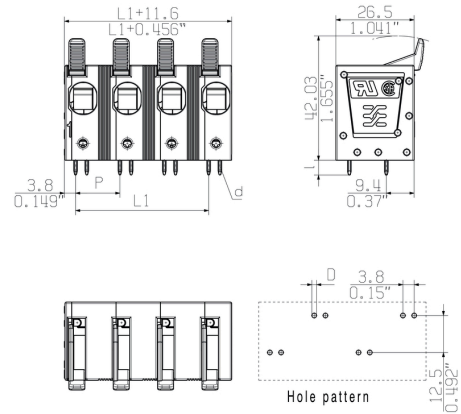

Derating curve

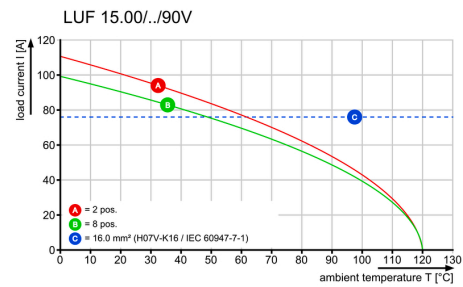

Derating curve

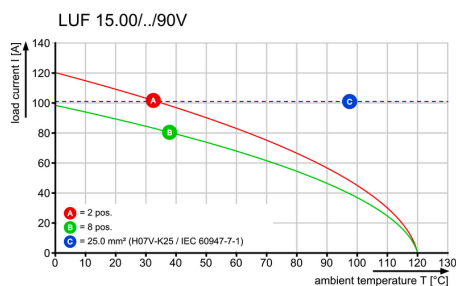

Product benefits

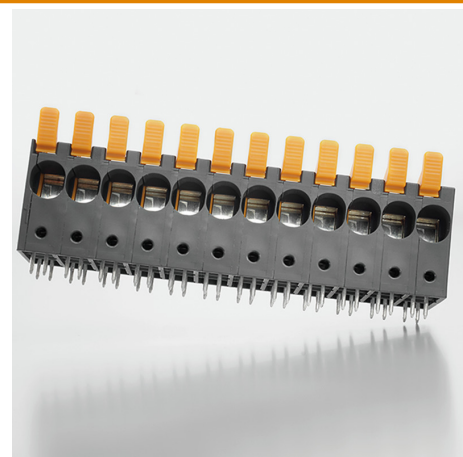

High stability through pin design

LUF 15.00/03/90V 5.0SN BK BX

Weidmüller Interface GmbH & Co. KG
Klingenbergstraße 26
D-32758 Detmold
Germany

Drawings

www.weidmueller.com

Product image

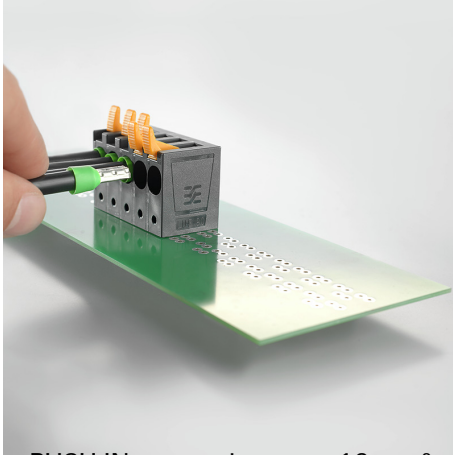

PUSH IN connection up to 16 mm²

Recommended wave soldering profiles

Weidmüller Interface GmbH & Co. KG
 Klingenbergstraße 16
 D-32758 Detmold
 Germany
 Fon: +49 5231 14-0
 Fax: +49 5231 14-292083
 www.weidmueller.com

Single Wave:



Double Wave:



Wave soldering profiles

Wired connection elements should be processed in accordance with the DIN EN 61760-1 standard. We have included two recommendations for practical wave soldering profiles, with which Weidmüller PCB terminals and connectors are qualified.

When choosing a suitable profile for your application, the following factors also need to be considered:

- PCB thickness
- Proportion of Cu in the layers
- Single/double-sided assembly
- Product range
- Heating and cooling rates

The single and double wave profiles each indicate the recommended operating range, including the maximum soldering temperature of 260°C. In practice, the maximum soldering temperature is quite often well below the above maximum profile.