

LMF 5.00/17/180 3.5SN BK BX

Weidmüller Interface GmbH & Co. KG
 Klingenbergstraße 26
 D-32758 Detmold
 Germany

www.weidmueller.com

Product image

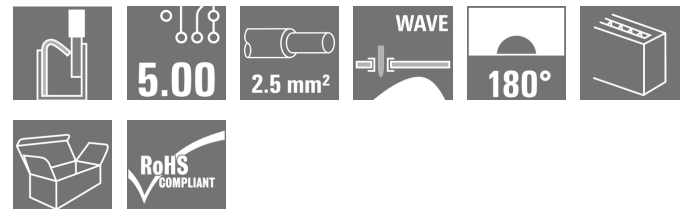

Similar to illustration

The new LMF allows us to meet the current market requirements for a PCB terminal with PUSH IN connection system for wire cross-sections up to 2.5 mm²

- PUSH IN connection system
- LMF with pusher for opening the terminal point
- LMFS without pusher, the terminal point is opened with a screwdriver
- Integrated test point
- 90° and 180° wire outlet direction

General ordering data

Version	Printed circuit board terminals, 5.00 mm, Number of poles: 17, 180°, Solder pin length (l): 3.5 mm, tinned, black, PUSH IN, Clamping range, max.: 2.5 mm ² , Box
Order No.	1425190000
Type	LMF 5.00/17/180 3.5SN BK BX
GTIN (EAN)	4050118229264
Qty.	15 pc(s).
Product data	IEC: 400 V / 24 A / 0.5 - 2.5 mm ² UL: 300 V / 20 A / AWG 24 - AWG 12
Packaging	Box

Creation date March 23, 2021 10:15:13 PM CET

LMF 5.00/17/180 3.5SN BK BX
Weidmüller Interface GmbH & Co. KG

Klingenbergstraße 26

D-32758 Detmold

Germany

www.weidmueller.com

Technical data
Dimensions and weights

Depth	14.8 mm	Depth (inches)	0.583 inch
Height	22.7 mm	Height (inches)	0.894 inch
Height of lowest version	19.2 mm	Net weight	25.699 g
Width	87.7 mm	Width (inches)	3.453 inch

System parameters

Product family	OMNIMATE Signal - series LMF	Wire connection method	PUSH IN
Mounting onto the PCB	THT solder connection	Conductor outlet direction	180°
Pitch in mm (P)	5 mm	Pitch in inches (P)	0.197 inch
Number of poles	17	Pin series quantity	2
Fitted by customer	No	Max. adjacent poles per row	24
Solder pin length (l)	3.5 mm	Solder pin dimensions	d = 0.8 mm
Solder eyelet hole diameter (D)	1.1 mm	Solder eyelet hole diameter tolerance (D)+	0, 1 mm
Number of solder pins per pole	2	Screwdriver blade	0.6 x 3.5
Screwdriver blade standard	DIN 5264	Stripping length	10 mm
L1 in mm	80 mm	L1 in inches	3.15 inch
Touch-safe protection acc. to DIN VDE 0470	IP 20	Touch-safe protection acc. to DIN VDE 57 106	Safe from finger touch

Material data

Insulating material	Wemid (PA)	Colour	black
Colour chart (similar)	RAL 9011	Comparative Tracking Index (CTI)	≥ 600
UL 94 flammability rating	V-0	Contact material	CuSn
Contact surface	tinned	Coating	4-6 µm SN
Tinning type	matt	Layer structure of solder connection	4...6 µm Sn matt
Storage temperature, min.	-40 °C	Storage temperature, max.	70 °C
Operating temperature, min.	-50 °C	Operating temperature, max.	120 °C
Temperature range, installation, min.	-25 °C	Temperature range, installation, max.	120 °C

Conductors suitable for connection

Clamping range, min.	0.12 mm ²
Clamping range, max.	2.5 mm ²
Wire connection cross section AWG, min.	AWG 24
Wire connection cross section AWG, max.	AWG 12
Solid, min. H05(07) V-U	0.5 mm ²
Solid, max. H05(07) V-U	2.5 mm ²
Flexible, min. H05(07) V-K	0.25 mm ²
Flexible, max. H05(07) V-K	2.5 mm ²
w. plastic collar ferrule, DIN 46228 pt 4, min.	0.25 mm ²
w. plastic collar ferrule, DIN 46228 pt 4, max.	2.5 mm ²
w. wire end ferrule, DIN 46228 pt 1, min.	0.25 mm ²
w. wire end ferrule, DIN 46228 pt 1, max.	2.5 mm ²
Plug gauge in accordance with EN 60999 a x b; ø	2.4 mm x 1.5 mm

Creation date March 23, 2021 10:15:13 PM CET

Catalogue status 12.03.2021 / We reserve the right to make technical changes.

LMF 5.00/17/180 3.5SN BK BX

Weidmüller Interface GmbH & Co. KG

Klingenbergstraße 26

D-32758 Detmold

Germany

www.weidmueller.com

Technical data

Clampable conductor	Cross-section for conductor connection	Type	fine-wired
		nominal	0.5 mm ²
wire end ferrule		Stripping length	nominal 12 mm
		Recommended wire-end ferrule	H0.5/16 OR
		Stripping length	nominal 10 mm
		Recommended wire-end ferrule	H0.5/10
Cross-section for conductor connection	Type	fine-wired	
	nominal	0.75 mm ²	
wire end ferrule		Stripping length	nominal 12 mm
		Recommended wire-end ferrule	H0.75/16 W
		Stripping length	nominal 10 mm
		Recommended wire-end ferrule	H0.75/10
Cross-section for conductor connection	Type	fine-wired	
	nominal	1 mm ²	
wire end ferrule		Stripping length	nominal 12 mm
		Recommended wire-end ferrule	H1.0/16D R
		Stripping length	nominal 10 mm
		Recommended wire-end ferrule	H1.0/10
Cross-section for conductor connection	Type	fine-wired	
	nominal	1.5 mm ²	
wire end ferrule		Stripping length	nominal 10 mm
		Recommended wire-end ferrule	H1.5/10
		Stripping length	nominal 12 mm
		Recommended wire-end ferrule	H1.5/16 R
Cross-section for conductor connection	Type	fine-wired	
	nominal	2.5 mm ²	
wire end ferrule		Stripping length	nominal 10 mm
		Recommended wire-end ferrule	H2.5/10

Reference text Length of ferrules is to be chosen depending on the product and the rated voltage., The outside diameter of the plastic collar should not be larger than the pitch (P)

Rated data acc. to IEC

tested acc. to standard	IEC 60664-1, IEC 61984	Rated current, min. number of poles (Tu=20°C)	24 A
Rated current, max. number of poles (Tu=20°C)	24 A	Rated current, min. number of poles (Tu=40°C)	24 A
Rated current, max. number of poles (Tu=40°C)	24 A	Rated voltage for surge voltage class / pollution degree II/2	400 V
Rated voltage for surge voltage class / pollution degree III/2	320 V	Rated voltage for surge voltage class / pollution degree III/3	250 V
Rated impulse voltage for surge voltage class/ pollution degree II/2	4 kV	Rated impulse voltage for surge voltage class/ pollution degree III/2	4 kV
Rated impulse voltage for surge voltage class/ contamination degree III/3	4 kV	Short-time withstand current resistance	3 x 1s with 120 A

Rated data acc. to CSA

Rated voltage (Use group B / CSA)	300 V	Rated voltage (Use group D / CSA)	300 V
Rated current (Use group B / CSA)	20 A	Rated current (Use group D / CSA)	10 A
Wire cross-section, AWG, min.	AWG 24	Wire cross-section, AWG, max.	AWG 12

Creation date March 23, 2021 10:15:13 PM CET

LMF 5.00/17/180 3.5SN BK BX

Weidmüller Interface GmbH & Co. KG
 Klingenbergstraße 26
 D-32758 Detmold
 Germany

www.weidmueller.com

Technical data**Rated data acc. to UL 1059**

Rated voltage (Use group B / UL 1059)	300 V	Rated voltage (Use group D / UL 1059)	300 V
Rated current (Use group B / UL 1059)	20 A	Rated current (Use group D / UL 1059)	10 A
Wire cross-section, AWG, min.	AWG 24	Wire cross-section, AWG, max.	AWG 12

Packing

Packaging	Box	VPE length	348 mm
VPE width	135 mm	VPE height	30 mm

Classifications

ETIM 6.0	EC002643	ETIM 7.0	EC002643
ECLASS 9.0	27-44-04-01	ECLASS 9.1	27-44-04-01
ECLASS 10.0	27-44-04-01	ECLASS 11.0	27-46-01-01

Important note

IPC conformity Conformity: The products are developed, manufactured and delivered according international recognized standards and norms and comply with the assured properties in the data sheet resp. fulfill decorative properties in accordance with IPC-A-610 "Class 2". Further claims on the products can be evaluated on request.

Notes

- Additional colours on request
- Rated current related to rated cross-section & min. No. of poles.
- Wire end ferrule without plastic collar to DIN 46228/1
- Wire end ferrule with plastic collar to DIN 46228/4
- P on drawing = pitch
- Rated data refer only to the component itself. Clearance and creepage distances to other components are to be designed in accordance with the relevant application standards.
- The test point can only be used as potential-pickup point.
- Long term storage of the product with average temperature of 50 °C and average humidity 70%, 36 months

Approvals

Approvals



ROHS

Conform

LMF 5.00/17/180 3.5SN BK BX

Weidmüller Interface GmbH & Co. KG
 Klingenbergstraße 26
 D-32758 Detmold
 Germany

www.weidmueller.com

Drawings

Dimensional drawing

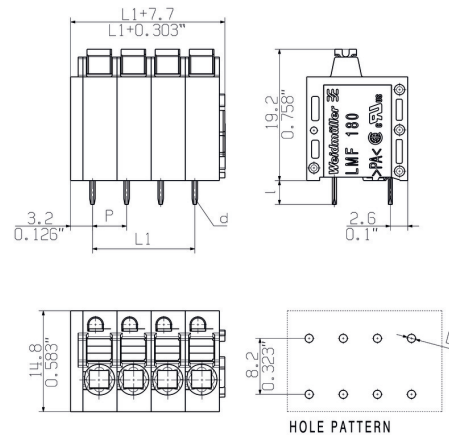

Graph

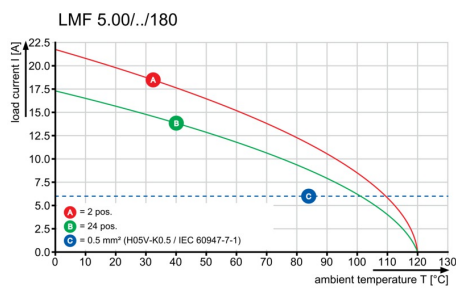

Graph

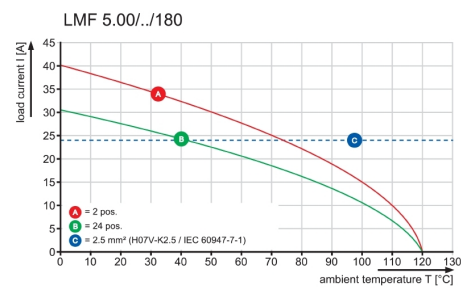

Product benefits

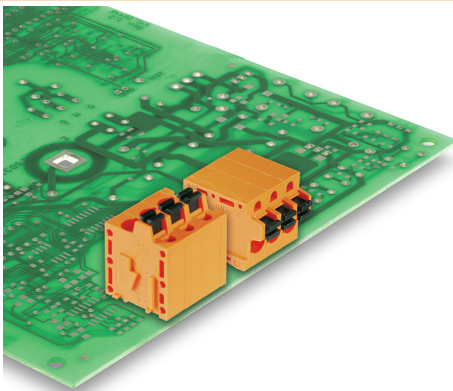

Optional conductor outlet direction
 Stable mechanical design

Product benefits

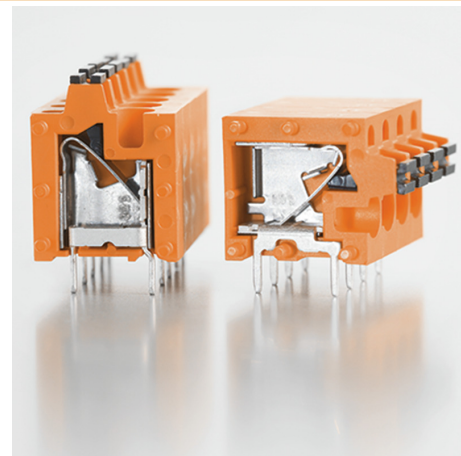

High reliability of the current capacity

LMF 5.00/17/180 3.5SN BK BX

Weidmüller Interface GmbH & Co. KG
Klingenbergstraße 26
D-32758 Detmold
Germany

www.weidmueller.com

Drawings

Product benefits

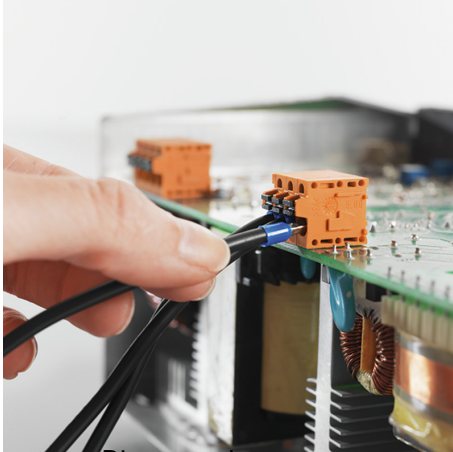

Direct conductor entry
Cross section up to 2.5 mm²

Product benefits

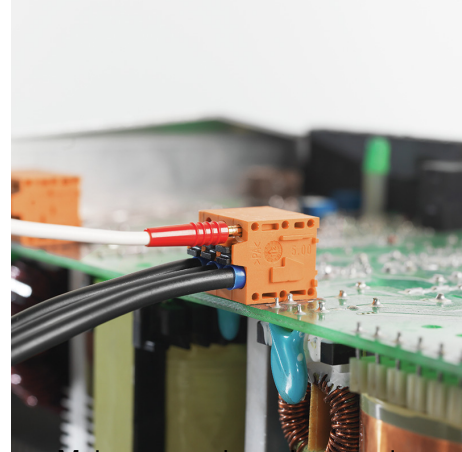

Maintenance through test point

Recommended wave soldering profiles

Weidmüller Interface GmbH & Co. KG
 Klingenbergstraße 16
 D-32758 Detmold
 Germany
 Fon: +49 5231 14-0
 Fax: +49 5231 14-292083
 www.weidmueller.com

Single Wave:



Double Wave:



Wave soldering profiles

Wired connection elements should be processed in accordance with the DIN EN 61760-1 standard. We have included two recommendations for practical wave soldering profiles, with which Weidmüller PCB terminals and connectors are qualified.

When choosing a suitable profile for your application, the following factors also need to be considered:

- PCB thickness
- Proportion of Cu in the layers
- Single/double-sided assembly
- Product range
- Heating and cooling rates

The single and double wave profiles each indicate the recommended operating range, including the maximum soldering temperature of 260°C. In practice, the maximum soldering temperature is quite often well below the above maximum profile.