

DRMKITP 24VDC 2CO LD

Weidmüller Interface GmbH & Co. KG
 Klingenbergstraße 26
 D-32758 Detmold
 Germany

www.weidmueller.com

Product image

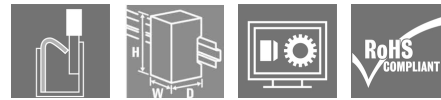

Similar to illustration

- Mounted kit consisting relay, socket and retaining clip
- 100 % function tested
- 100 % check of the dielectric strenght between input - output
- 2 CO contacts
- Optional with mechanical status indicator
- Optional Test button with coloured identification of coils (AC red / DC blue)
- Bright status LED (AC coil: red / DC coil: green)

General ordering data

| | |
|----------------|--|
| Version | D-SERIES DRM, Relay module, Number of contacts: 2, CO contact AgNi flash gold-plated, Rated control voltage: 24 V DC, Continuous current: 10 A, PUSH IN, Test button: No |
| Order No. | 2576110000 |
| Type | DRMKITP 24VDC 2CO LD |
| GTIN (EAN) | 4050118585865 |
| Qty. | 10 pc(s). |
| Relevant base | 7760056362 |
| Relevant relay | 7760056060 |

Creation date April 16, 2021 3:09:53 AM CEST

DRMKITP 24VDC 2CO LD

Weidmüller Interface GmbH & Co. KG

Klingenbergstraße 26

D-32758 Detmold

Germany

www.weidmueller.com

Technical data

Dimensions and weights

| | | | |
|----------------|------------|-----------------|------------|
| Depth | 82.3 mm | Depth (inches) | 3.24 inch |
| Height | 101.8 mm | Height (inches) | 4.008 inch |
| Net weight | 99.09 g | Width | 30.6 mm |
| Width (inches) | 1.205 inch | | |

Temperatures

| | | | |
|---------------------|--|-----------------------|----------------|
| Storage temperature | -40 °C...70 °C | Operating temperature | -40 °C...60 °C |
| Humidity | 35...85 % rel. humidity, no condensation | | |

Environmental Product Compliance

| | |
|------------|----------------|
| REACH SVHC | Lead 7439-92-1 |
|------------|----------------|

Control side

| | | | |
|-----------------------|---------------------|--------------------------------|-----------------|
| Coil resistance | 650 Ω ± 10 % | Power rating | 0.9 W |
| Protective circuit | Free-wheeling diode | Pull-in/drop-out voltage, typ. | 18 V / 2.4 V DC |
| Rated control voltage | 24 V DC | Rated current DC | 36.9 mA |
| Status indicator | Green LED | | |

Load side

| | | | |
|---|--------------|----------------------|----------------------------|
| AC switching capacity (resistive), max. | 2500 VA | Continuous current | 10 A |
| DC switching capacity (resistive), max. | 240 W @ 24 V | Inrush current | 20 A / 50 ms |
| Max. switching frequency at rated load | 0.1 Hz | Min. switching power | 10 mA @ 12 V, 100 mA @ 5 V |
| Rated switching voltage | 250 V AC | Switch-off delay | ≤ 20 ms |
| Switch-on delay | ≤ 20 ms | | |

Contact data

| | | | |
|-------------------------|---------------------------------------|--------------------|---------|
| Contact type | 2 CO contact (AgNi flash gold-plated) | Contact resistance | ≤ 50 mΩ |
| Mechanical service life | 20 x 10 ⁶ switching cycles | | |

General data

| | |
|--------------------------------------|-------|
| Rail | TS 35 |
| Test button | No |
| Mechanical switch position indicator | Yes |
| Colour | black |

DRMKITP 24VDC 2CO LD

Weidmüller Interface GmbH & Co. KG

 Klingenbergstraße 26
 D-32758 Detmold
 Germany

www.weidmueller.com

Technical data

| | | |
|------------------------------------|--------------------------|------------------------|
| UL94 flammability rating component | Component | Housing |
| | UL94 flammability rating | V-2 |
| | Component | Pusher |
| | UL94 flammability rating | HB |
| | Component | Mounting foot |
| | UL94 flammability rating | HB |
| | Component | Retaining clip |
| | UL94 flammability rating | HB |
| | Component | Relay cover |
| | UL94 flammability rating | V-2 |
| | Component | Relay baseplate |
| | UL94 flammability rating | V-0 |
| | Component | Relay status indicator |
| | UL94 flammability rating | HB |
| Component | Relay test button | |
| UL94 flammability rating | HB | |

Insulation coordination

| | | | |
|---|-----------------------------|--|--------------------------------|
| Clearance and creepage distances for control side - load side | ≥ 5.5 mm | Dielectric strength for control side - load side | 1.8 kV _{eff} / 1 min. |
| Dielectric strength of neighbouring contacts | 1 kV _{eff} / 1 min | Dielectric strength of open contact | 1 kV _{eff} / 1 min |
| Insulating material group | C | Pollution severity | 2 |
| Protection degree | IP20 | Rated voltage | 250 V |
| Surge voltage category | III | | |

Further details of approvals / standards

| | | | |
|-------------------------------|---------|------------------------------|---------|
| Certificate no. (cURus) relay | E312083 | Certificate no. (cURus) base | E355547 |
|-------------------------------|---------|------------------------------|---------|

Connection data

| | | | |
|---|---------------------|---|----------------------|
| Wire connection method | PUSH IN | Stripping length, rated connection | 10 mm |
| Clamping range, rated connection | 1.5 mm ² | Clamping range, min. | 0.14 mm ² |
| Clamping range, max. | 1.5 mm ² | Wire connection cross section AWG, min. | AWG 26 |
| Wire connection cross section AWG, max. | AWG 16 | Wire cross-section, solid, min. | 0.14 mm ² |
| Wire cross-section, solid, max. | 1.5 mm ² | Wire connection cross section, finely stranded, min. | 0.14 mm ² |
| Wire connection cross section, finely stranded, max. | 1.5 mm ² | Wire connection cross-section, finely stranded with wire-end ferrules DIN 46228/4, min. | 0.14 mm ² |
| Wire connection cross-section, finely stranded with wire-end ferrules DIN 46228/4, max. | 1 mm ² | Conductor cross-section, flexible, AEH (DIN 46228-1), min. | 0.14 mm ² |
| Conductor cross-section, flexible, AEH (DIN 46228-1), max. | 1.5 mm ² | Blade size | 0.4 x 2.5 mm |

Classifications

| | | | |
|-------------|-------------|-------------|-------------|
| ETIM 6.0 | EC001437 | ETIM 7.0 | EC001437 |
| ECLASS 9.0 | 27-37-16-01 | ECLASS 9.1 | 27-37-16-01 |
| ECLASS 10.0 | 27-37-16-01 | ECLASS 11.0 | 27-37-16-01 |

DRMKITP 24VDC 2CO LD

Weidmüller Interface GmbH & Co. KG
Klingenbergstraße 26
D-32758 Detmold
Germany

www.weidmueller.com

Technical data**Approvals**

Approvals



ROHS

Conform

Downloads

Approval/Certificate/Document of
Conformity

[EU Konformitätserklärung / EU Declaration of Conformity](#)

Engineering Data

[STEP](#)

Engineering Data

[EPLAN](#)

Brochure/Catalogue

[Catalogues in PDF-format](#)

DRMKITP 24VDC 2CO LD

Weidmüller Interface GmbH & Co. KG
 Klingenbergstraße 26
 D-32758 Detmold
 Germany

www.weidmueller.com

Drawings

Wiring diagram

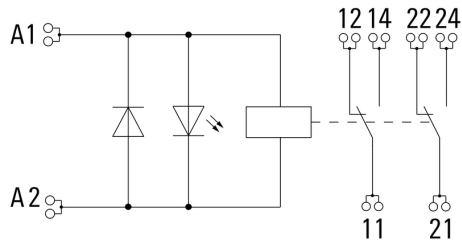

Graph

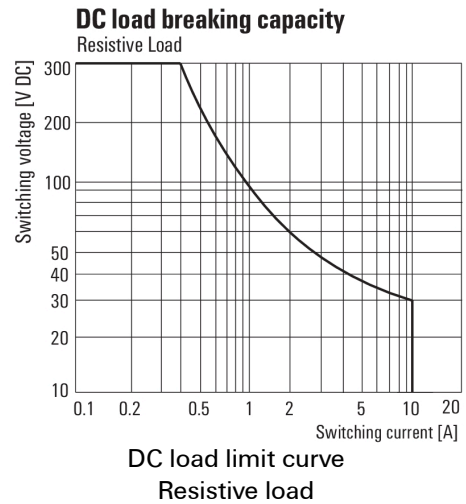

Graph

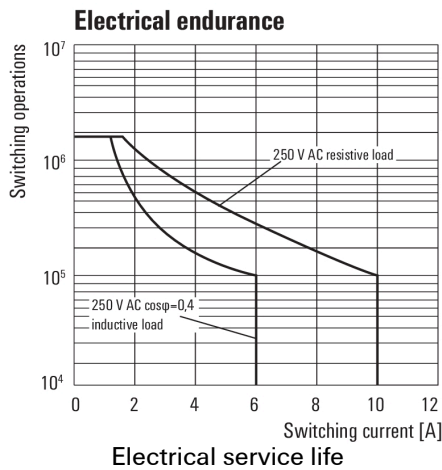

Graph

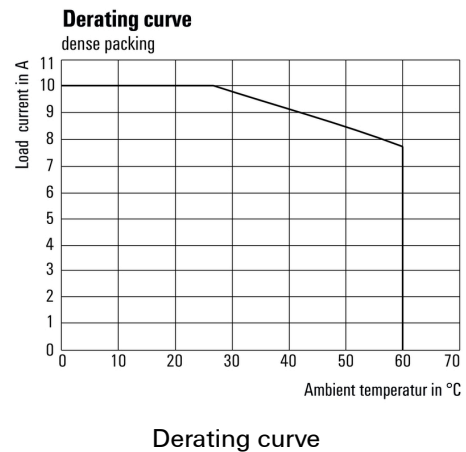

Graph

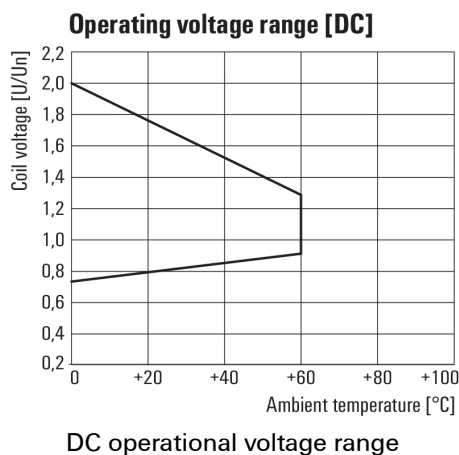

Dimensional drawing

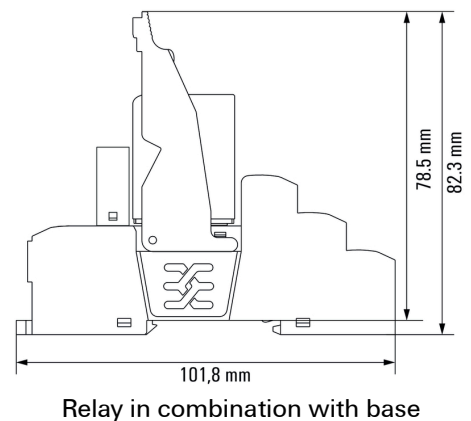

DRMKITP 24VDC 2CO LD

Weidmüller Interface GmbH & Co. KG
 Klingenbergstraße 26
 D-32758 Detmold
 Germany

www.weidmueller.com

Drawings

Miscellaneous

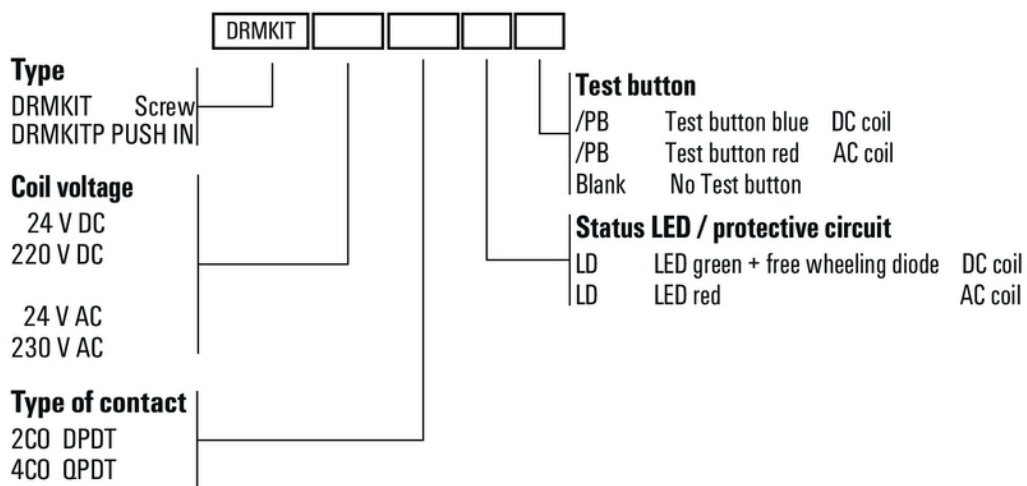

Type codes