

## PM 5.00/12/90 3.5SN OR BX

**Weidmüller Interface GmbH & Co. KG**  
 Klingenbergstraße 26  
 D-32758 Detmold  
 Germany

www.weidmueller.com

### Product image

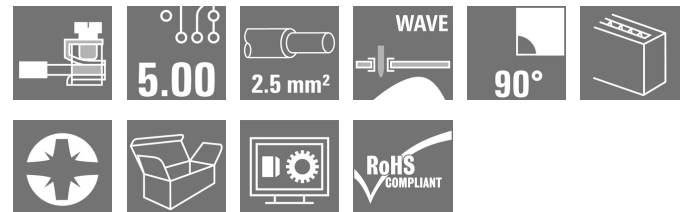

Similar to illustration

PCB terminal with leaf spring connection at 5.00 and 5.08 mm pitch. Conductor outlet direction 90°. Suitable for conductor cross-sections up to 2.5 mm<sup>2</sup>.

### General ordering data

Version	Printed circuit board terminals, 5.00 mm, Number of poles: 12, 90°, Solder pin length (l): 3.5 mm, tinned, orange, Pressure clamp connection, Clamping range, max. : 2.5 mm <sup>2</sup> , Box
Order No.	<a href="#">1234740000</a>
Type	PM 5.00/12/90 3.5SN OR BX
GTIN (EAN)	4050118019247
Qty.	100 pc(s).
Product data	IEC: 600 V / 24 A / 0.13 - 2.5 mm <sup>2</sup> UL: 300 V / 15 A / AWG 26 - AWG 14
Packaging	Box

Creation date March 23, 2021 10:36:33 AM CET

## PM 5.00/12/90 3.5SN OR BX

**Weidmüller Interface GmbH & Co. KG**

Klingenbergstraße 26

D-32758 Detmold

Germany

www.weidmueller.com

## Technical data

### Dimensions and weights

Depth	8 mm	Depth (inches)	0.315 inch
Height	13.5 mm	Height (inches)	0.531 inch
Height of lowest version	10 mm	Net weight	14.4 g
Width	60.6 mm	Width (inches)	2.386 inch

### Environmental Product Compliance

REACH SVHC	Lead 7439-92-1
------------	----------------

### System parameters

Product family	OMNIMATE Signal - series PM	Wire connection method	Pressure clamp connection
Mounting onto the PCB	THT solder connection	Conductor outlet direction	90°
Pitch in mm (P)	5 mm	Pitch in inches (P)	0.197 inch
Number of poles	12	Pin series quantity	1
Fitted by customer	Yes	Max. adjacent poles per row	24
Solder pin length (l)	3.5 mm	Solder pin dimensions	d = 1.0 mm
Solder eyelet hole diameter (D)	1.3 mm	Solder eyelet hole diameter tolerance (D)	+ 0,1 mm
Number of solder pins per pole	1	Screwdriver blade	0.6 x 3.5
Screwdriver blade standard	DIN 5264	Tightening torque, min.	0.4 Nm
Tightening torque, max.	0.5 Nm	Clamping screw	M 2.5
Stripping length	6 mm	L1 in mm	55 mm
L1 in inches	2.165 inch	Touch-safe protection acc. to DIN VDE 0470	IP 20, above the PCB; with conductor connected
Touch-safe protection acc. to DIN VDE 57 106	Safe from finger touch		

### Material data

Insulating material	Wemid (PA)	Colour	orange
Colour chart (similar)	RAL 2000	Insulating material group	I
Comparative Tracking Index (CTI)	≥ 600	UL 94 flammability rating	V-0
Contact material	Copper alloy	Contact surface	tinned
Coating	1-3 µm Ni, 4-6 µm SN	Tinning type	matt
Layer structure of solder connection	1.5...3.5 µm Ni / 4...6 µm Sn matt	Storage temperature, min.	-40 °C
Storage temperature, max.	70 °C	Operating temperature, min.	-50 °C
Operating temperature, max.	120 °C	Temperature range, installation, min.	-25 °C
Temperature range, installation, max.	120 °C		

### Conductors suitable for connection

Clamping range, min.	0.13 mm <sup>2</sup>
Clamping range, max.	2.5 mm <sup>2</sup>
Wire connection cross section AWG, min.	AWG 26
Wire connection cross section AWG, max.	AWG 14
Solid, min. H05(07) V-U	0.13 mm <sup>2</sup>
Solid, max. H05(07) V-U	2.5 mm <sup>2</sup>
Flexible, min. H05(07) V-K	0.13 mm <sup>2</sup>
Flexible, max. H05(07) V-K	2.5 mm <sup>2</sup>
w. plastic collar ferrule, DIN 46228 pt 4,	0.25 mm <sup>2</sup> min.

Creation date March 23, 2021 10:36:33 AM CET

Catalogue status 12.03.2021 / We reserve the right to make technical changes.

## PM 5.00/12/90 3.5SN OR BX

**Weidmüller Interface GmbH & Co. KG**  
 Klingenbergstraße 26  
 D-32758 Detmold  
 Germany

www.weidmueller.com

## Technical data

w. plastic collar ferrule, DIN 46228 pt 4, 1.5 mm<sup>2</sup>  
 max.

w. wire end ferrule, DIN 46228 pt 1, 0.25 mm<sup>2</sup>  
 min.

w. wire end ferrule, DIN 46228 pt 1, 1.5 mm<sup>2</sup>  
 max.

Clampable conductor	Cross-section for conductor connection	Type	fine-wired
		nominal	0.5 mm <sup>2</sup>
wire end ferrule	wire end ferrule	Stripping length	nominal 8 mm
		Recommended wire-end ferrule	<a href="#">H0.5/12 OR</a>
		Stripping length	nominal 6 mm
		Recommended wire-end ferrule	<a href="#">H0.5/6</a>
Cross-section for conductor connection	wire end ferrule	Type	fine-wired
		nominal	0.75 mm <sup>2</sup>
		Stripping length	nominal 8 mm
		Recommended wire-end ferrule	<a href="#">H0.75/12 W</a>
Cross-section for conductor connection	wire end ferrule	Type	fine-wired
		nominal	1 mm <sup>2</sup>
		Stripping length	nominal 8 mm
		Recommended wire-end ferrule	<a href="#">H1.0/12 GE</a>
Cross-section for conductor connection	wire end ferrule	Type	fine-wired
		nominal	0.25 mm <sup>2</sup>
		Stripping length	nominal 8 mm
		Recommended wire-end ferrule	<a href="#">H0.25/10 HBL</a>
Cross-section for conductor connection	wire end ferrule	Type	fine-wired
		nominal	0.34 mm <sup>2</sup>
		Stripping length	nominal 8 mm
		Recommended wire-end ferrule	<a href="#">H0.34/10 TK</a>

Reference text Length of ferrules is to be chosen depending on the product and the rated voltage., The outside diameter of the plastic collar should not be larger than the pitch (P)

### Rated data acc. to IEC

tested acc. to standard	IEC 60664-1, IEC 61984	Rated current, min. number of poles (Tu=20°C)	24 A
Rated current, max. number of poles (Tu=20°C)	24 A	Rated current, min. number of poles (Tu=40°C)	24 A
Rated current, max. number of poles (Tu=40°C)	24 A	Rated voltage for surge voltage class / pollution degree II/2	600 V
Rated voltage for surge voltage class / pollution degree III/2	250 V	Rated voltage for surge voltage class / pollution degree III/3	250 V
Rated impulse voltage for surge voltage class/ pollution degree II/2	4 kV	Rated impulse voltage for surge voltage class/ pollution degree III/2	4 kV
Rated impulse voltage for surge voltage class/ contamination degree III/3	4 kV	Short-time withstand current resistance	3 x 1s with 120 A

Creation date March 23, 2021 10:36:33 AM CET

## PM 5.00/12/90 3.5SN OR BX

**Weidmüller Interface GmbH & Co. KG**  
 Klingenbergstraße 26  
 D-32758 Detmold  
 Germany

www.weidmueller.com

## Technical data

## Rated data acc. to CSA

Institute (CSA)		Certificate No. (CSA)	200039-1815154
Rated voltage (Use group B / CSA)	300 V	Rated voltage (Use group D / CSA)	300 V
Rated current (Use group B / CSA)	15 A	Rated current (Use group D / CSA)	10 A
Wire cross-section, AWG, min.	AWG 26	Wire cross-section, AWG, max.	AWG 14
Reference to approval values	Specifications are maximum values, details - see approval certificate.		

## Rated data acc. to UL 1059

Institute (cURus)		Certificate No. (cURus)	E60693
Rated voltage (Use group B / UL 1059)	300 V	Rated voltage (Use group D / UL 1059)	300 V
Rated current (Use group B / UL 1059)	15 A	Rated current (Use group D / UL 1059)	10 A
Wire cross-section, AWG, min.	AWG 26	Wire cross-section, AWG, max.	AWG 14
Reference to approval values	Specifications are maximum values, details - see approval certificate.		

## Packing

Packaging	Box	VPE length	0
VPE width	0	VPE height	0

## Classifications

ETIM 6.0	EC002643	ETIM 7.0	EC002643
ECLASS 9.0	27-44-04-01	ECLASS 9.1	27-44-04-01
ECLASS 10.0	27-44-04-01	ECLASS 11.0	27-46-01-01

## Important note

IPC conformity	Conformity: The products are developed, manufactured and delivered according international recognized standards and norms and comply with the assured properties in the data sheet resp. fulfill decorative properties in accordance with IPC-A-610 "Class 2". Further claims on the products can be evaluated on request.
Notes	<ul style="list-style-type: none"> <li>Rated current related to rated cross-section &amp; min. No. of poles.</li> <li>Wire end ferrule without plastic collar to DIN 46228/1</li> <li>Wire end ferrule with plastic collar to DIN 46228/4</li> <li>The data given under CSA relates to a cUL approval - E60693</li> <li>P on drawing = pitch</li> <li>Rated data refer only to the component itself. Clearance and creepage distances to other components are to be designed in accordance with the relevant application standards.</li> <li>Long term storage of the product with average temperature of 50 °C and average humidity 70%, 36 months</li> </ul>

Creation date March 23, 2021 10:36:33 AM CET

Catalogue status 12.03.2021 / We reserve the right to make technical changes.

**Data sheet****PM 5.00/12/90 3.5SN OR BX****Weidmüller Interface GmbH & Co. KG**  
Klingenbergstraße 26  
D-32758 Detmold  
Germany

www.weidmueller.com

**Technical data****Approvals**

Approvals



ROHS	Conform
UL File Number Search	E60693

**Downloads**

Approval/Certificate/Document of Conformity	<a href="#">Declaration of the Manufacturer</a>
Engineering Data	<a href="#">STEP</a>
Engineering Data	<a href="#">EPLAN, WSCAD</a>

**PM 5.00/12/90 3.5SN OR BX**

**Weidmüller Interface GmbH & Co. KG**  
 Klingenbergstraße 26  
 D-32758 Detmold  
 Germany

www.weidmueller.com

**Drawings**

**Dimensional drawing**

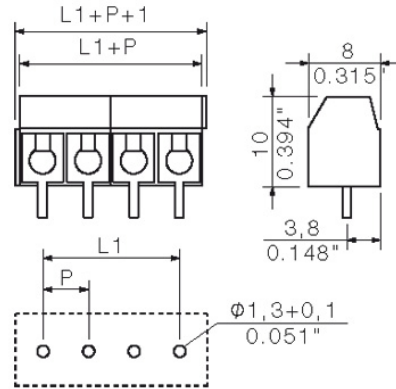

**Graph**



**Graph**

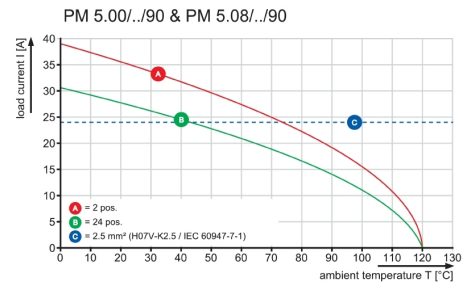

09

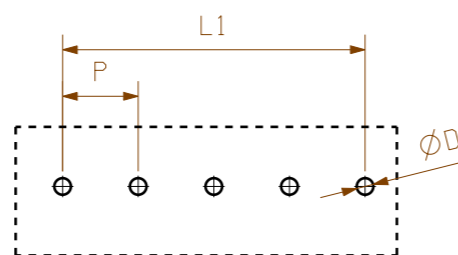
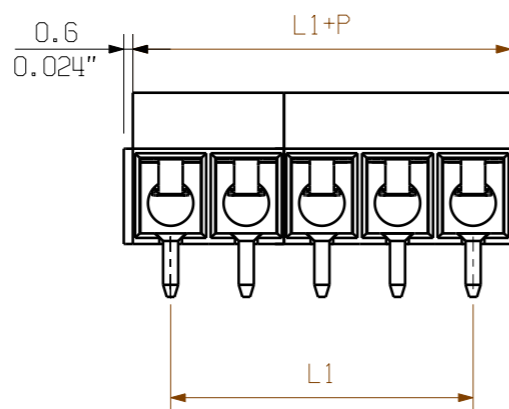
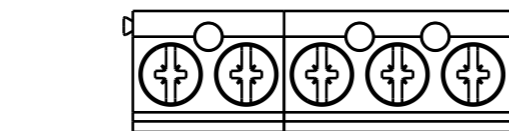

PCB LAYOUT

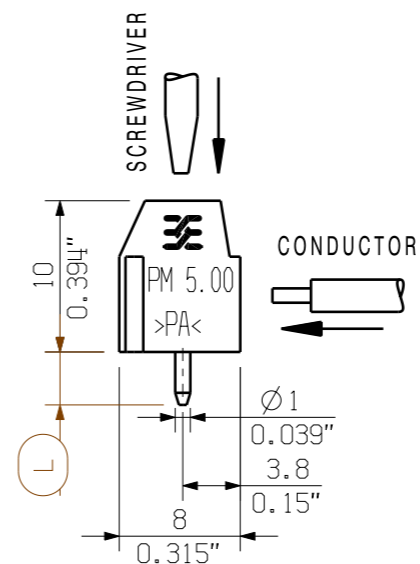

$L = 3.5 \pm 0.2$

$P = 5.00$

$L1 = (N-1) \times P$

KUNDENZEICHUNG  
CUSTOMER DRAWING

For the mounting of PCBs, it should be noted that the rated data stated in the catalog relates only to the PCB components alone.

The necessary creepage and clearance paths must be observed in connection with the respective applicant in accordance to IEC 664 / VDE 0110.

The current-carrying capacity and pitch tolerance is to be determined according to DIN IEC 326 part 3 very fine.

Weidmüller PCB components are tested to the DIN EN 61984 standard, and are valid for its field of application. Provided that the components are used to the intended purpose, all requirements with respect to the occurring of electrical, mechanical, thermic and corrosive stress will be satisfied.

14	65.00	2.559
13	60.00	2.362
12	55.00	2.165
11	50.00	1.969
10	45.00	1.772
9	40.00	1.575
8	35.00	1.378
7	30.00	1.181
6	25.00	0.984
5	20.00	0.787
4	15.00	0.591
3	10.00	0.394
2	5.00	0.197
N	L1 [mm]	L1 [inch]

<b>GENERAL TOLERANCE:</b> DIN ISO 2768-m		91688/5 20.01.17 MA_J 01		Cat.no.:	
RoHS COMPLIANT	Max. nos.	Modification		<b>Weidmüller</b>	
Scale: 5/1		Drawn	Date	Name	C 41698 09 Drawing no. Issue no. Sheet 01 of 01 sheets
Supersedes:		Responsible	Checked	Name	
		Approved	Date	Name	
PM 5.00/.../90 ... LEITERPLATTENKLEMME PCB TERMINAL			Product file: PM 5.00		
					7062

The reproduction, distribution and utilization of this document as well as the communication of its contents to others without explicit authorization is prohibited. Offenders will be held liable for the payment of damages. Weidmüller exclusively reserves the right to file for patents, utility models or designs.

© Weidmüller Interface GmbH & Co. KG

## Recommended wave soldering profiles

**Weidmüller Interface GmbH & Co. KG**  
 Klängenbergstraße 16  
 D-32758 Detmold  
 Germany  
 Fon: +49 5231 14-0  
 Fax: +49 5231 14-292083  
 www.weidmueller.com

### Single Wave:



### Double Wave:



### Wave soldering profiles

Wired connection elements should be processed in accordance with the DIN EN 61760-1 standard. We have included two recommendations for practical wave soldering profiles, with which Weidmüller PCB terminals and connectors are qualified.

When choosing a suitable profile for your application, the following factors also need to be considered:

- PCB thickness
- Proportion of Cu in the layers
- Single/double-sided assembly
- Product range
- Heating and cooling rates

The single and double wave profiles each indicate the recommended operating range, including the maximum soldering temperature of 260°C. In practice, the maximum soldering temperature is quite often well below the above maximum profile.

