

XPSMC16ZPACK

safety controller XPS-MC - 24 V DC - 16 input - 30 LEDs signalling



Main

Range of product	Preventa Safety automation
Product or component type	Kit configurable safety controller
Safety module name	XPSMC
Safety use category	SIL 3 maximum conforming to IEC 61508 PLE maximum conforming to EN/ISO 13849-1 Category 4 maximum conforming to EN 954-1/EN/ISO 13849-1
Type of start	Configurable
Standards	EN 1760-1/ISO 13856-1 EN 574/ISO 13851 EN 954-1/EN/ISO 13849-1 EN/IEC 60204-1 EN/IEC 60947-5-1 EN/IEC 61496-1 IEC 61508
Product certifications	CSA TÜV UL
[Us] rated supply voltage	24 V DC - 20...20 %
Number of inputs	16
Communication port protocol	Modbus with 1 RJ45 port(s), serial link, transmission rate: 1200 bps, 2400 bps, 4800 bps, 9600 bps or 19200 bps
Safety level	Can reach SIL 3 conforming to IEC 61508 Can reach PL e/category 4 conforming to EN 954-1/EN/ISO 13849-1

The information provided in this documentation contains general descriptions and/or technical characteristics of the performance of the products contained herein. This documentation is not intended as a substitute for and is not to be used for determining suitability or reliability of these products for specific user applications. It is the duty of any such user or integrator to perform the appropriate and complete risk analysis, evaluation and testing of the products with respect to the relevant specific application or use thereof. Neither Schneider Electric Industries SAS nor any of its affiliates or subsidiaries shall be responsible or liable for misuse of the information contained herein.

Complementary

Kit composition	<p>Configuration software Connection cable Ethernet cable 2m Packaging small model for software configuration Printed packaging label 80 x 50 mm Safety controller Set of cage clamp terminals Set of screw terminals USB/RS485 converter VDE slot screwdriver 2.5 x 75 mm</p>
Function of module	<p>Two-hand control (category 3) conforming to EN 574/ISO 13851 Light curtain monitoring (category 4) conforming to EN/IEC 61496 Zero speed detection Shaft/Chain breaking monitor Safety time delays Safety mat monitoring Position selector Muting function of light curtains Monitoring safety stop at top dead centre on eccentric press Magnetic switch monitoring Hydraulic press Guard monitoring with 1 or 2 limit switches Guard monitoring for injection presses and blowing machines Foot switch monitoring Enabling switch monitoring, 2 or 3 contacts Emergency stop monitoring, with or without time delay, 1 or 2-channel wiring Eccentric press Dynamic monitoring of hydraulic valves on linear presses</p>
Synchronisation time between inputs	Depending on configuration selected
Power consumption	12 W
Input protection type	External fuse 16 A
[Uc] control circuit voltage	28.8 V
Line resistance	100 Ohm, cable length: <= 2000 m
Output type	Solid state, 6 circuit(s), volt-free 2 relays, 2 NO contacts (4 NO total) circuit(s)
Breaking capacity	C300 : inrush 1800 VA AC-15 for relay output C300 : holding 180 VA AC-15 for relay output
Breaking capacity	1.5 A / 24 V - L/R = 50 ms, DC-13 for relay output 2 A / 24 V for static output circuit
Output thermal current	6 A for 1 output and 2 A for the other for relay output 4 A for both outputs simultaneously
[Ith] conventional free air thermal current	<= 6.5 A for static output circuit <= 16 A for relay output
Associated fuse rating	6 A fast blow for relay output 4 A gL for relay output 16 A gL for power supply
Minimum output current	10 mA for relay output
Minimum output voltage	17 V for relay output
Response time	Configurable : 20 ms or 30 ms with software XPSMCWIN
[Ui] rated insulation voltage	300 V, degree of pollution 2 conforming to IEC 60647-5-1, DIN VDE 0110 part 1
[Uimp] rated impulse withstand voltage	4 kV overvoltage category III conforming to IEC 60647-5-1, DIN VDE 0110 part 1
Method of access	Slave
Exchange size	14 words
Number of addresses	1...247 for Modbus
Parity	Odd for Modbus No for Modbus Even for Modbus
Data format	RTU (Remote Terminal Unit) mode 2 stop bits without parity 1 stop bit even or odd 1 start bit/8 data bits
Supported modbus function	03: information and errors 02: 32-bit input data/8-bit output data 01: 8-bit output data/32-bit input data
Local signalling	30 LEDs
Mounting support	Mounting plate

Depth	153 mm
Height	151.5 mm
Width	74 mm
Product weight	0.82 kg

Environment

IP degree of protection	IP20 conforming to EN/IEC 60529
Ambient air temperature for operation	-10...55 °C
Ambient air temperature for storage	-25...85 °C

Dimensions

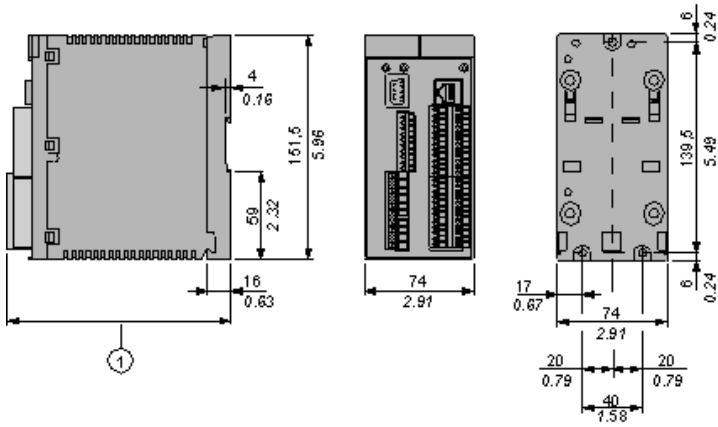

- 1 When using XPSMCTS• connectors this dimension is 153 mm (6.02 in)
When using XPSMCTC• connectors this dimension is 151,5 mm (5.96 in)

Installation

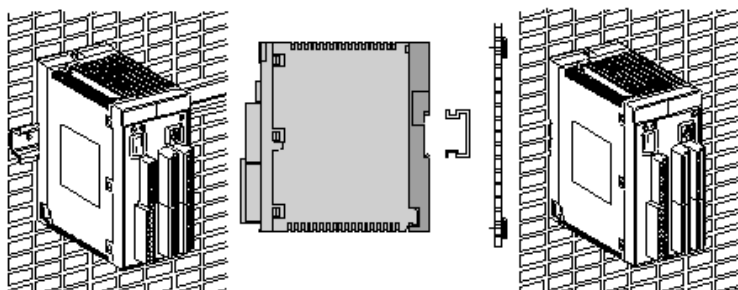

Metal adaptor for fixing on metal: DIN rail 35 mm/1.38 in.

Wiring Diagrams

Refer to the Instruction Sheet

To download the instruction sheet, follow below procedure:

XPSAC5121
module XPSAC - Emergency stop - 24 V AC DC
[Download XPSAC5121 product datasheet](#)

Download & Documents 1 to 3 of 3 (Total: -1)

Instruction sheet

XPSAC... Safety module for emergency stop and switch monitoring	English 2012-07-04	pdf (28)
-----------------------------------------------------------------	--------------------	----------

Image of product

Emergency stop and switch monitoring	2010-11-10	{Select : }
--------------------------------------	------------	-------------

Certificate



Russian certificate	English 2010-07-07	pdf (60)
---------------------	--------------------	----------

1

2

- 1 Click on Download & Documents.
- 2 Click on Instruction sheet.

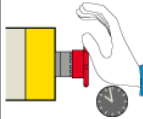
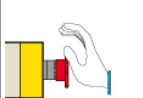
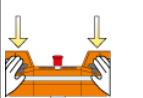
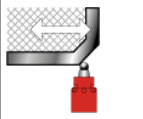
Safety Functions

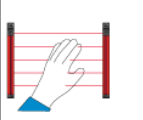
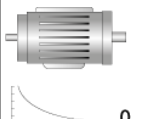
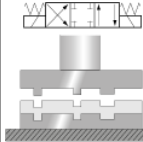
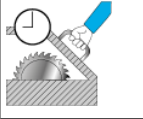
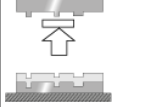
	<ul style="list-style-type: none"> • Emergency stop monitoring with time delay: <ul style="list-style-type: none"> ○ 1 channel wiring, with automatic start. ○ 2 channel wiring, with start button.
	<ul style="list-style-type: none"> • Emergency stop monitoring without time delay: <ul style="list-style-type: none"> ○ 1 channel wiring, with automatic start. ○ 2 channel wiring, with start button.
	<ul style="list-style-type: none"> • Two-hand control.
	<ul style="list-style-type: none"> • Guard monitoring: <ul style="list-style-type: none"> ○ with 1 limit switch. ○ with 2 limit switches. ○ with 2 limit switches, with guard locking. • Guard monitoring for injection presses and blowing machines.
	<ul style="list-style-type: none"> • Magnetic switch monitoring.
	<ul style="list-style-type: none"> • Sensing mat monitoring.
	<ul style="list-style-type: none"> • Light curtains monitoring: <ul style="list-style-type: none"> ○ Relay output type. ○ Solid-state output type. • "Muting" function for light curtains.
	<ul style="list-style-type: none"> • Zero speed detection.
	<ul style="list-style-type: none"> • Dynamic monitoring of hydraulic valves on linear presses.
	<ul style="list-style-type: none"> • Safety time delays.
	<ul style="list-style-type: none"> • Monitoring safety stop at top dead centre on eccentric press. • Hydraulic press. • Eccentric press.



- Enabling switching monitoring:
 - 2 contact type.
 - 3 contact type.

Other functions:

- Foot switch monitoring
- Chain shaft breakage monitoring
- Position selector