



### Main

Range of product	Modicon M221
Product or component type	Logic controller
[Us] rated supply voltage	24 V DC
Discrete input number	9 discrete input conforming to IEC 61131-2 Type 1 including 4 fast input
Analogue input number	2 at input range: 0...10 V
Discrete output type	Transistor
Discrete output number	7 transistor including 2 fast output
Discrete output voltage	24 V DC
Discrete output current	0.5 A

### Complementary

Discrete I/O number	16
Number of I/O expansion module	<= 4 for relay output <= 4 for transistor output
Supply voltage limits	20.4...28.8 V
Inrush current	<= 35 A
Power consumption in W	<= 4.6 W at 24 V without I/O expansion module <= 11 W at 24 V with max number of I/O expansion module
Power supply output current	0.15 A at 24 V for expansion bus 0.325 A at 5 V for expansion bus
Discrete input logic	Sink or source (positive/negative)
Discrete input voltage	24 V
Discrete input voltage type	DC
Analogue input resolution	10 bits
LSB value	10 mV
Conversion time	1 ms per channel + 1 controller cycle time for analog input
Permitted overload on inputs	+/- 13 V DC for analog input permanent +/- 30 V DC for analog input with 5 min maximum
Voltage state1 guaranteed	>= 15 V for input
Current state 1 guaranteed	>= 4.2 mA for discrete input >= 2.6 mA for fast input
Voltage state 0 guaranteed	<= 5 V for input
Current state 0 guaranteed	<= 0.6 mA for fast input <= 1.3 mA for discrete input
Discrete input current	5 mA for fast input 7 mA for discrete input
Input impedance	4.9 kOhm for fast input 100 kOhm for analog input 3.4 kOhm for discrete input
Response time	300 µs turn-on, turn-off operation for output; other terminals terminal 50 µs turn-on, turn-off operation for output; Q2...Q3 terminal 5 µs turn-on, turn-off operation for output; Q0...Q1 terminal 100 µs turn-off operation for input; other terminals terminal 5 µs turn-off operation for fast input; I0, I1, I6, I7 terminal 35 µs turn-on operation for input; other terminals terminal 5 µs turn-on operation for fast input; I0, I1, I6, I7 terminal 35 µs turn-off operation for input; I2...I5 terminal
Configurable filtering time	12 ms for input 3 ms for input 0 ms for input

The information provided in this documentation contains general descriptions and/or technical characteristics of the performance of the products contained herein. This documentation is not intended as a substitute for and is not to be used for determining suitability or reliability of these products for specific user applications. It is the duty of any such user or integrator to perform the appropriate and complete risk analysis, evaluation and testing of the products with respect to the relevant specific application or use thereof. Neither Schneider Electric Industries SAS nor any of its affiliates or subsidiaries shall be responsible or liable for misuse of the information contained herein.

Discrete output logic	Positive logic (source)
Current per output common	3.5 A
Output frequency	0.1 kHz for output at Q4...Q6 terminal 5 kHz for output at Q2...Q3 terminal 100 kHz for fast output (PWM/PLS mode) at Q0...Q1 terminal
Absolute accuracy error	+/- 1 % of full scale for analog input
Leakage current	0.1 mA for transistor output
Voltage drop	<= 1 V
Mechanical durability	>= 20000000 cycles for transistor output
Tungsten load	<= 12 W for output and fast output
Protection type	Overload and short-circuit protection at 1 A
Reset time	1 s automatic reset
Memory capacity	256 kB for internal variables RAM 256 kB for user application and data RAM with 10000 instructions
Data backed up	256 kB built-in flash memory for backup of application and data
Data storage equipment	2 GB SD card optional
Battery type	BR2032 lithium non-rechargeable, battery life: 4 yr
Backup time	1 year at 25 °C by interruption of power supply
Execution time for 1 KInstruction	0.3 ms for event and periodic task
Execution time per instruction	0.2 µs Boolean
Exct time for event task	60 µs response time
Maximum size of object areas	512 %M memory bits 8000 %MW memory words 512 %KW constant words 255 %TM timers 255 %C counters
Realtime clock	With
Clock drift	<= 30 s/month at 25 °C
Regulation loop	Adjustable PID regulator up to 14 simultaneous loops
Positioning functions	Position PTO 1 axe(s) CW/CCW mode (100 kHz) Position PTO 2 axe(s) pulse/direction mode (100 kHz)
Function available	PWM PLS Frequency generator
Counting input number	4 fast input (HSC mode) (counting frequency: 100 kHz), counting capacity: 32 bits
Counter function	A/B Pulse/Direction Single phase
Integrated connection type	Ethernet with connector RJ45 Non isolated serial link "serial 1" with connector RJ45 and interface RS232/RS485 USB port with connector mini B USB 2.0
Supply	Serial serial link supply at 5 V 200 mA
Transmission rate	480 Mbit/s - communication protocol: USB 1.2...115.2 kbit/s (115.2 kbit/s by default) for bus length of 3 m - communication protocol: RS232 1.2...115.2 kbit/s (115.2 kbit/s by default) for bus length of 15 m - communication protocol: RS485
Communication port protocol	: Ethernet protocol Non isolated serial link : Modbus protocol master/slave - RTU/ASCII or SoMachine-Network USB port : USB protocol - SoMachine-Network
Port Ethernet	10BASE-T/100BASE-TX 1 port with 100 m copper cable
Communication service	DHCP client Ethernet/IP adapter Modbus TCP server Modbus TCP client Modbus TCP slave device

Local signalling	Ethernet network link yellow for Link (Link Status) Ethernet network activity green for ACT 1 LED green for SL 1 LED per channel green for I/O state 1 LED red for BAT 1 LED green for SD card access (SD) 1 LED red for module error (ERR) 1 LED green for RUN 1 LED green for PWR
Electrical connection	Mini B USB 2.0 connector for a programming terminal Connector, 4 terminal(s) for analogue inputs Terminal block, 3 terminal(s) for connecting the 24 V DC power supply Removable screw terminal block for outputs Removable screw terminal block for inputs
Cable length	<= 1 m unshielded cable for analog input <= 30 m unshielded cable for digital input <= 3 m shielded cable for fast output <= 30 m unshielded cable for output <= 10 m shielded cable for fast input
Insulation	Non-insulated between analogue inputs Non-insulated between analogue input and internal logic 500 V AC between output and internal logic Non-insulated between inputs 500 V AC between fast input and internal logic 500 V AC between input and internal logic
Marking	CE
Mounting support	Plate or panel with fixing kit Top hat type TH35-7.5 rail conforming to IEC 60715 Top hat type TH35-15 rail conforming to IEC 60715
Height	70 mm
Depth	70 mm
Width	95 mm
Product weight	0.346 kg

## Environment

Standards	EN/IEC 60664-1 EN/IEC 61131-2 EN/IEC 61010-2-201
Product certifications	CSA CULus LR IACS E10 RCM EAC DNV-GL
Environmental characteristic	Ordinary and hazardous location
Resistance to electrostatic discharge	4 kV on contact conforming to EN/IEC 61000-4-2 8 kV in air conforming to EN/IEC 61000-4-2
Resistance to electromagnetic fields	1 V/m ( 2...2.7 GHz) conforming to EN/IEC 61000-4-3 3 V/m ( 1.4 GHz...2 GHz) conforming to EN/IEC 61000-4-3 10 V/m ( 80 MHz...1 GHz) conforming to EN/IEC 61000-4-3
Resistance to magnetic fields	30 A/m at 50...60 Hz conforming to EN/IEC 61000-4-8
Resistance to fast transients	1 kV for serial link conforming to EN/IEC 61000-4-4 1 kV for Ethernet line conforming to EN/IEC 61000-4-4 1 kV for I/O conforming to EN/IEC 61000-4-4 2 kV for relay output conforming to EN/IEC 61000-4-4 2 kV for power lines conforming to EN/IEC 61000-4-4
Surge withstand	0.5 kV for power lines (DC) in common mode conforming to EN/IEC 61000-4-5 1 kV for relay output in differential mode conforming to EN/IEC 61000-4-5 1 kV for power lines (AC) in differential mode conforming to EN/IEC 61000-4-5 0.5 kV for power lines (DC) in differential mode conforming to EN/IEC 61000-4-5 1 kV for shielded cable in common mode conforming to EN/IEC 61000-4-5 1 kV for I/O in common mode conforming to EN/IEC 61000-4-5 2 kV for relay output in common mode conforming to EN/IEC 61000-4-5 2 kV for power lines (AC) in common mode conforming to EN/IEC 61000-4-5
Resistance to conducted disturbances, induced by radio frequency fields	10 Vrms (spot frequency (2, 3, 4, 6.2, 8.2, 12.6, 16.5, 18.8, 22, 25 MHz)) conforming to Marine specification (LR, ABS, DNV, GL) 3 Vrms (0.1...80 MHz) conforming to Marine specification (LR, ABS, DNV, GL) 10 Vrms (0.15...80 MHz) conforming to EN/IEC 61000-4-6

Electromagnetic emission	Radiated emissions conforming to EN/IEC 55011 class A 10 m, 200 MHz...1 GHz : 47 dB $\mu$ V/m QP Radiated emissions conforming to EN/IEC 55011 class A 10 m, 30...230 MHz : 40 dB $\mu$ V/m QP Conducted emissions conforming to EN/IEC 55011 power lines, 1.5...30 MHz : 63 dB $\mu$ V/m QP Conducted emissions conforming to EN/IEC 55011 power lines, 150 kHz...1.5 MHz : 79...63 dB $\mu$ V/m QP Conducted emissions conforming to EN/IEC 55011 power lines, 10...150 kHz : 120...69 dB $\mu$ V/m QP Conducted emissions conforming to EN/IEC 55011 power lines (AC), 0.5...300 MHz : 73 dB $\mu$ V/m QP/60 dB $\mu$ V/m AV Conducted emissions conforming to EN/IEC 55011 power lines (AC), 0.15...0.5 MHz : 79 dB $\mu$ V/m QP/66 dB $\mu$ V/m AV
Immunity to microbreaks	10 ms
Ambient air temperature for operation	-10...35 °C for vertical installation -10...55 °C for horizontal installation
Ambient air temperature for storage	-25...70 °C
Relative humidity	10...95 % without condensation in storage 10...95 % without condensation in operation
IP degree of protection	IP20 with protective cover in place
Pollution degree	<= 2
Operating altitude	0...2000 m
Storage altitude	0...3000 m
Vibration resistance	1 gn (vibration frequency: 8.4...150 Hz) on panel mounting 1 gn (vibration frequency: 8.4...150 Hz) on symmetrical rail 3.5 mm (vibration frequency: 5...8.4 Hz) on panel mounting 3.5 mm (vibration frequency: 5...8.4 Hz) on symmetrical rail
Shock resistance	147 m/s <sup>2</sup> (test wave duration:11 ms)

### Offer Sustainability

Sustainable offer status	Green Premium product
RoHS (date code: YYWW)	Compliant - since 1415 - <a href="#">Schneider Electric declaration of conformity</a>
REACH	Reference contains SVHC above the threshold - <a href="#">go to CaP for more details</a>
Product environmental profile	Available <a href="#">Download Product Environmental</a>
Product end of life instructions	Available <a href="#">Download End Of Life Manual</a>

Dimensions

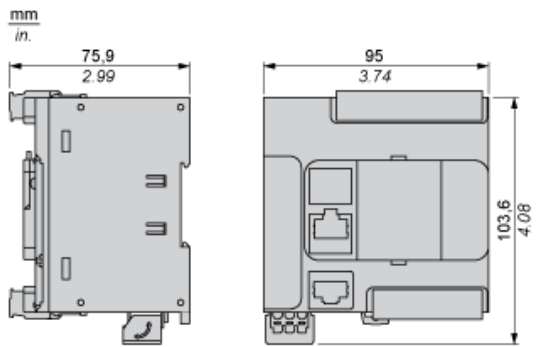

---

Mounting on a Rail

---

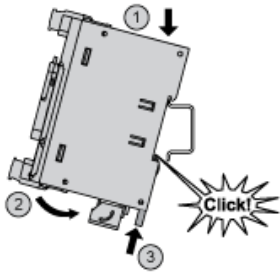

---

Direct Mounting on a Panel Surface

---

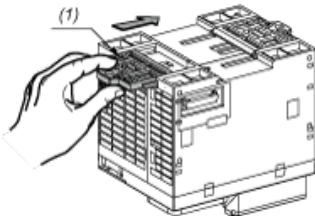

- (1) Install a mounting strip

Mounting Hole Layout

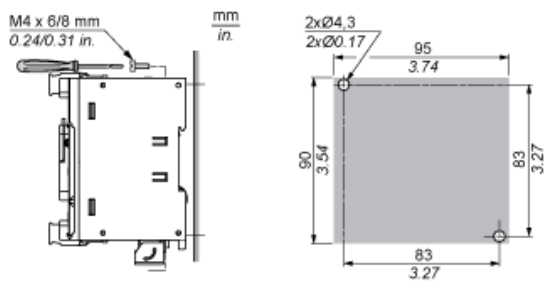

---

Mounting

---

Correct Mounting Position

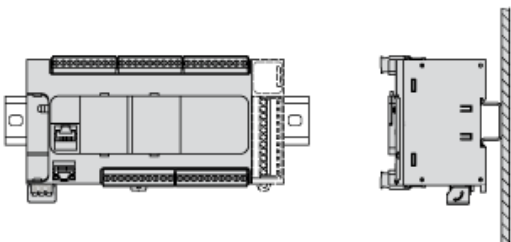

## Acceptable Mounting Position

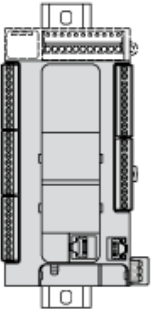

## Incorrect Mounting Position

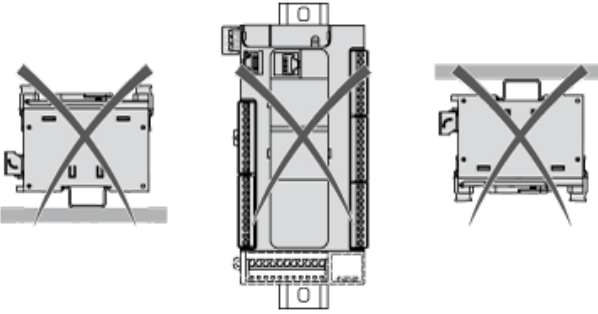

## Clearance

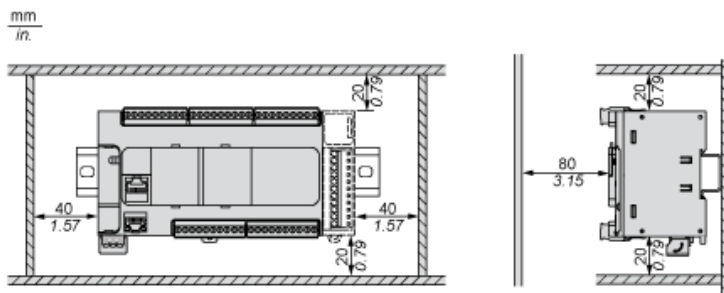

### Digital Inputs

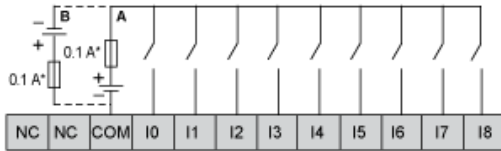

- (\*) Type T fuse
- (A) Sink wiring (positive logic).
- (B) Source wiring (negative logic).

### Connection of the Fast Inputs

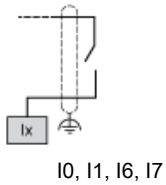

### Transistor Outputs

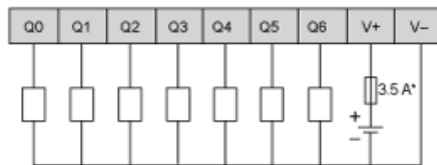

- (\*) Type T fuse

### Connection of the Fast Outputs

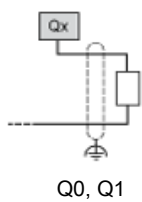

### Analog Inputs

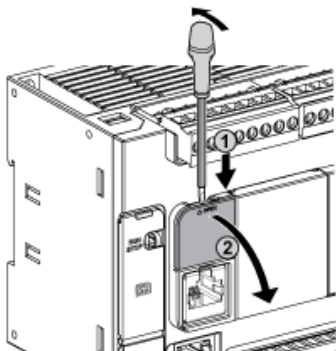

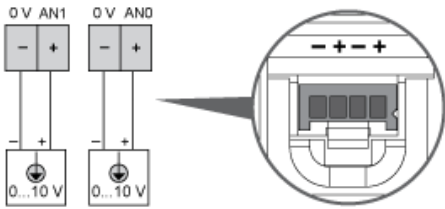

The (-) poles are connected internally.

Pin	Wire Color
0 V	Black
AN1	Red
0 V	Black
AN0	Red

## Ethernet Connection

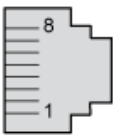

Pin N°	Signal
1	TD+
2	TD-
3	RD+
4	-
5	-
6	RD-
7	-
8	-

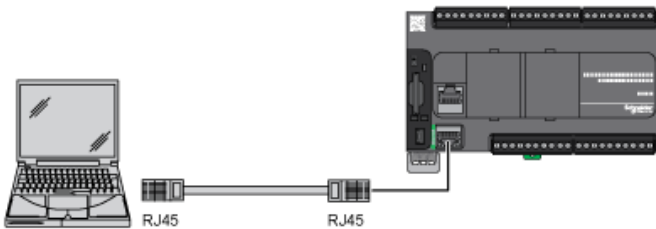

## USB Mini-B Connection

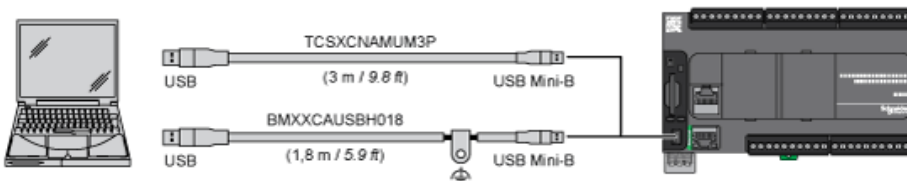

## SL1 Connection

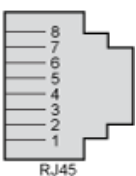

SL1

N °	RS 232	RS 485
1	RxD	N.C.
2	TxD	N.C.
3	RTS	N.C.
4	N.C.	D1
5	N.C.	D0
6	CTS	N.C.
7	N.C.*	5 Vdc
8	Common	Common

N.C.: not connected

\* : 5 Vdc delivered by the controller. Do not connect.

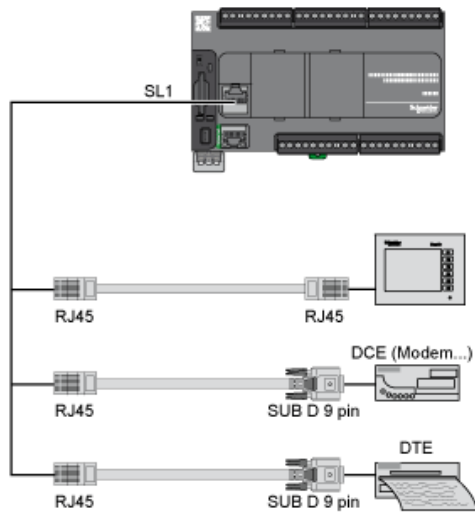

---

Derating Curves

---

Embedded Digital Inputs (No Cartridge)

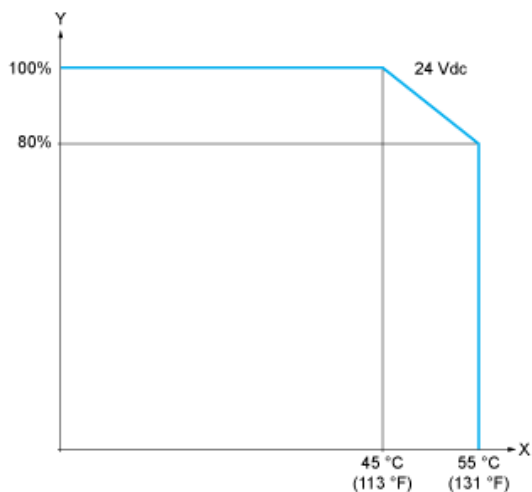

X : Ambient temperature  
Y : Input simultaneous ON ratio

Embedded Digital Inputs (with Cartridge)

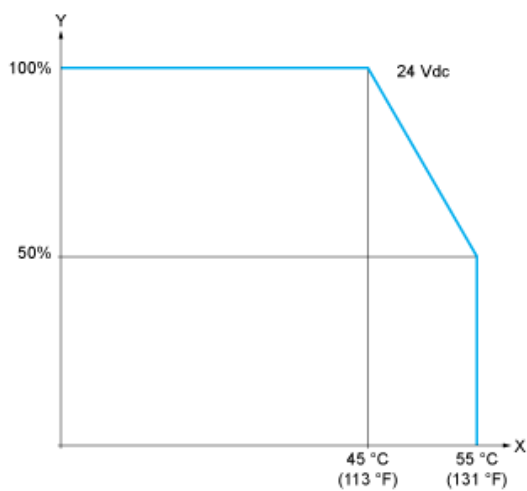

X : Ambient temperature  
Y : Input simultaneous ON ratio

---

Derating Curves

---

### Embedded Digital Outputs (No Cartridge)

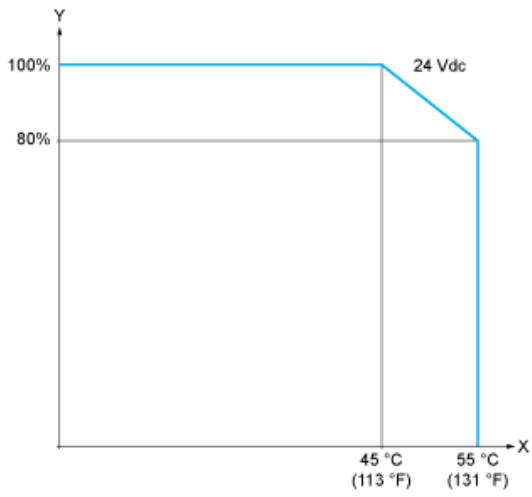

X : Ambient temperature  
Y : Output simultaneous ON ratio

### Embedded Digital Outputs (with Cartridge)

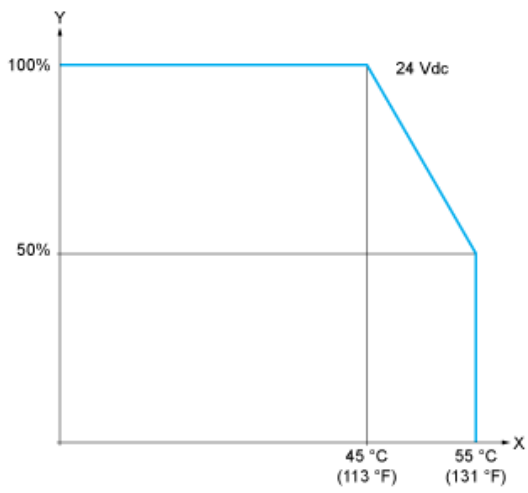

X : Ambient temperature  
Y : Output simultaneous ON ratio