

BCF 3.81/10/180 SN OR BX

Weidmüller Interface GmbH & Co. KG
 Klingenbergstraße 26
 D-32758 Detmold
 Germany

www.weidmueller.com

Product image

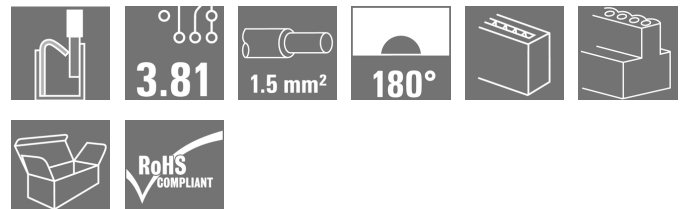
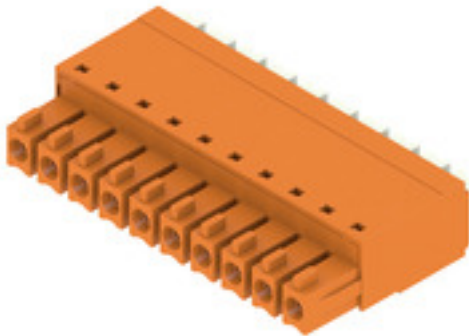

PUSH IN - Weidmüller's innovative connection system simplifies the wire connection process.

The benefits for users and applications:

- High packaging density due to very low component height. Simply insert the prepared wire - finished
- High component density with the compact SCDN / SCDN-THR two-tier pin header
- Simplified processing due to integrated push buttons for opening the clamping unit
- Intuitive handling – since the wire-entry area and handling area are clearly separated
- tool-free locking and releasing when using Weidmüller's patented release latch (LR)

The Weidmüller plug-in connectors, pitch 3.81 mm (0.15 inch), are compatible with the layout of customary plug-in connectors, can be coded and provide space for printing.

General ordering data

Version	PCB plug-in connector, female plug, 3.81 mm, Number of poles: 10, 180°, PUSH IN, Tension-clamp connection, Clamping range, max. : 1.5 mm², Box
Order No.	1969170000
Type	BCF 3.81/10/180 SN OR BX
GTIN (EAN)	4032248677948
Qty.	50 pc(s).
Product data	IEC: 320 V / 17.5 A / 0.14 - 1.5 mm² UL: 300 V / 10 A / AWG 26 - AWG 16
Packaging	Box

BCF 3.81/10/180 SN OR BX**Weidmüller Interface GmbH & Co. KG**

Klingenbergstraße 26

D-32758 Detmold

Germany

www.weidmueller.com

Technical data**Dimensions and weights**

Depth	22 mm	Depth (inches)	0.866 inch
Height	7.9 mm	Height (inches)	0.311 inch
Net weight	7.2 g	Width	38.19 mm
Width (inches)	1.504 inch		

System Parameters

Product family	OMNIMATE Signal - series BC/SC 3.81	Type of connection	Field connection
Wire connection method	PUSH IN, Tension-clamp connection	Pitch in mm (P)	3.81 mm
Pitch in inches (P)	0.15 inch	Conductor outlet direction	180°
Number of poles	10	L1 in mm	34.29 mm
L1 in inches	1.35 inch	Number of rows	1
Pin series quantity	1	Rated cross-section	1 mm ²
Touch-safe protection acc. to DIN VDE 57 106	Safe from finger touch	Touch-safe protection acc. to DIN VDE 0470	IP 20
Volume resistance	≤5 mΩ	Can be coded	Yes
Stripping length	9 mm	Screwdriver blade	0.4 x 2.5
Screwdriver blade standard	DIN 5264	Plugging cycles	25
Plugging force/pole, max.	8 N	Pulling force/pole, max.	7 N

Material data

Insulating material	PA 66 GF 30	Colour	orange
Colour chart (similar)	RAL 2000	Insulating material group	II
Comparative Tracking Index (CTI)	≥ 550	Insulation strength	≥ 10 ⁸ Ω
UL 94 flammability rating	V-0	Contact material	Copper alloy
Contact surface	tinned	Layer structure of plug contact	4...8 μm Sn matt
Storage temperature, min.	-40 °C	Storage temperature, max.	70 °C
Operating temperature, min.	-50 °C	Operating temperature, max.	120 °C
Temperature range, installation, min.	-25 °C	Temperature range, installation, max.	120 °C

Conductors suitable for connection

Clamping range, min.	0.14 mm ²
Clamping range, max.	1.5 mm ²
Wire connection cross section AWG, min.	AWG 26
Wire connection cross section AWG, max.	AWG 16
Solid, min. H05(07) V-U	0.14 mm ²
Solid, max. H05(07) V-U	1.5 mm ²
Flexible, min. H05(07) V-K	0.14 mm ²
Flexible, max. H05(07) V-K	1.5 mm ²
w. plastic collar ferrule, DIN 46228 pt 4, min.	0.25 mm ²
w. plastic collar ferrule, DIN 46228 pt 4, max.	1 mm ²
w. wire end ferrule, DIN 46228 pt 1, min.	0.25 mm ²
w. wire end ferrule, DIN 46228 pt 1, max.	1.5 mm ²
Plug gauge in accordance with EN 60999 a x b; ø	2.4 mm x 1.5 mm; 1.9mm

Creation date March 26, 2021 4:01:06 PM CET

BCF 3.81/10/180 SN OR BX

Weidmüller Interface GmbH & Co. KG

Klingenbergstraße 26

D-32758 Detmold

Germany

www.weidmueller.com

Technical data

Clampable conductor	Cross-section for conductor connection	Type	fine-wired	
		nominal	0.5 mm ²	
	wire end ferrule	Stripping length	nominal	12 mm
		Recommended wire-end ferrule	H0.5/16 OR	
		Stripping length	nominal	10 mm
		Recommended wire-end ferrule	H0.5/10	
	Cross-section for conductor connection	Type	fine-wired	
		nominal	0.75 mm ²	
	wire end ferrule	Stripping length	nominal	12 mm
		Recommended wire-end ferrule	H0.75/16 W	
		Stripping length	nominal	10 mm
		Recommended wire-end ferrule	H0.75/10	
Cross-section for conductor connection	Type	fine-wired		
	nominal	1 mm ²		
wire end ferrule	Stripping length	nominal	12 mm	
	Recommended wire-end ferrule	H1.0/16D R		
	Stripping length	nominal	10 mm	
	Recommended wire-end ferrule	H1.0/10		
Cross-section for conductor connection	Type	fine-wired		
	nominal	0.34 mm ²		
wire end ferrule	Stripping length	nominal	10 mm	
	Recommended wire-end ferrule	H0.34/12 TK		

Reference text

The outside diameter of the plastic collar should not be larger than the pitch (P), Length of ferrules is to be chosen depending on the product and the rated voltage.

Rated data acc. to IEC

tested acc. to standard	IEC 60664-1, IEC 61984	Rated current, min. number of poles (Tu=20°C)	17.5 A
Rated current, max. number of poles (Tu=20°C)	17.5 A	Rated current, min. number of poles (Tu=40°C)	17.5 A
Rated current, max. number of poles (Tu=40°C)	16.3 A	Rated voltage for surge voltage class / pollution degree II/2	320 V
Rated voltage for surge voltage class / pollution degree III/2	160 V	Rated voltage for surge voltage class / pollution degree III/3	160 V
Rated impulse voltage for surge voltage class/ pollution degree II/2	2.5 kV	Rated impulse voltage for surge voltage class/ pollution degree III/2	2.5 kV
Rated impulse voltage for surge voltage class/ contamination degree III/3	2.5 kV	Short-time withstand current resistance	3 x 1s with 76 A

BCF 3.81/10/180 SN OR BX

Weidmüller Interface GmbH & Co. KG

Klingenbergstraße 26

D-32758 Detmold

Germany

www.weidmueller.com

Technical data

Rated data acc. to CSA

Institute (CSA)



Certificate No. (CSA)

200039-1121690

Rated voltage (Use group B / CSA)	300 V
Rated voltage (Use group D / CSA)	300 V
Rated current (Use group C / CSA)	11 A
Wire cross-section, AWG, min.	AWG 26

Rated voltage (Use group C / CSA)	50 V
Rated current (Use group B / CSA)	11 A
Rated current (Use group D / CSA)	11 A
Wire cross-section, AWG, max.	AWG 16

Reference to approval values

Specifications are maximum values, details - see approval certificate.

Rated data acc. to UL 1059

Institute (cURus)



Certificate No. (cURus)

E60693

Rated voltage (Use group B / UL 1059)	300 V
Rated current (Use group B / UL 1059)	10 A
Wire cross-section, AWG, min.	AWG 26

Rated voltage (Use group D / UL 1059)	300 V
Rated current (Use group D / UL 1059)	10 A
Wire cross-section, AWG, max.	AWG 16

Reference to approval values

Specifications are maximum values, details - see approval certificate.

Packing

Packaging	Box	VPE length	20 mm
VPE width	115 mm	VPE height	250 mm

Type tests

Test: Durability of markings	Standard	DIN EN 61984 section 7.3.2 / 09.02 taking pattern from DIN EN 60068-2-70 / 07.96
	Test	mark of origin, type identification, rated voltage, rated cross-section, pitch, type of material, approval marking UL, approval marking CSA
	Evaluation	available
	Test	durability
Test: Misengagement (Non-interchangeability)	Evaluation	passed
	Standard	DIN EN 61984 section 6.3 and 6.9.1 / 09.02, DIN EN 60512-13-5 / 11.06
	Test	180° turned without coding elements
	Evaluation	passed
Test: Misengagement (Non-interchangeability)	Test	visual examination
	Evaluation	passed

BCF 3.81/10/180 SN OR BX

Weidmüller Interface GmbH & Co. KG
 Klingenbergstraße 26
 D-32758 Detmold
 Germany

www.weidmueller.com

Technical data

Test: Clampable cross section	Standard	DIN EN 60999-1 section 7 and 9.1 / 12.00, DIN EN 60947-1 section 8.2.4.5.1 / 12.02	
	Conductor type	Type of conductor and conductor cross-section	solid 0.14 mm ²
		Type of conductor and conductor cross-section	stranded 0.14 mm ²
		Type of conductor and conductor cross-section	solid 1.5 mm ²
		Type of conductor and conductor cross-section	stranded 1.5 mm ²
		Type of conductor and conductor cross-section	AWG 26/1
		Type of conductor and conductor cross-section	AWG 26/19
		Type of conductor and conductor cross-section	AWG 16/1
		Type of conductor and conductor cross-section	AWG 16/19
Evaluation	passed		
Test for damage to and accidental loosening of conductors	Standard	DIN EN 60999-1 section 9.4 / 12.00	
	Requirement	0.2 kg	
	Conductor type	Type of conductor and conductor cross-section	stranded 0.25 mm ²
		Type of conductor and conductor cross-section	AWG 26/1
		Type of conductor and conductor cross-section	AWG 16/19
	Evaluation	passed	
	Requirement	0.3 kg	
	Conductor type	Type of conductor and conductor cross-section	solid 0.5 mm ²
	Evaluation	passed	
	Requirement	0.4 kg	
Conductor type	Type of conductor and conductor cross-section	solid 1.5 mm ²	
	Type of conductor and conductor cross-section	stranded 1.5 mm ²	
	Type of conductor and conductor cross-section	AWG 16/1	
	Type of conductor and conductor cross-section	AWG 16/19	
Evaluation	passed		

BCF 3.81/10/180 SN OR BX

Weidmüller Interface GmbH & Co. KG
 Klingenbergstraße 26
 D-32758 Detmold
 Germany

www.weidmueller.com

Technical data

Pull-out test	Standard	DIN EN 60999-1 section 9.5 / 12.00		
	Requirement	≥10 N		
	Conductor type	Type of conductor and conductor cross-section	stranded 0.25 mm ²	
		Type of conductor and conductor cross-section	AWG 26/1	
		Type of conductor and conductor cross-section	AWG 26/19	
	Evaluation	passed		
	Requirement	≥20 N		
	Conductor type	Type of conductor and conductor cross-section	H05V-U0.5	
		Evaluation	passed	
	Requirement	≥40 N		
	Conductor type	Type of conductor and conductor cross-section	H07V-U1.5	
		Type of conductor and conductor cross-section	H07V-K1.5	
		Type of conductor and conductor cross-section	AWG 16/1	
		Type of conductor and conductor cross-section	AWG 16/19	
	Evaluation	passed		

Classifications

ETIM 6.0	EC002638	ETIM 7.0	EC002638
ECLASS 9.0	27-44-03-09	ECLASS 9.1	27-44-03-09
ECLASS 10.0	27-44-03-09	ECLASS 11.0	27-46-02-02

BCF 3.81/10/180 SN OR BX

Weidmüller Interface GmbH & Co. KG
 Klingenbergstraße 26
 D-32758 Detmold
 Germany

www.weidmueller.com

Technical data

Important note

IPC conformity	Conformity: The products are developed, manufactured and delivered according international recognized standards and norms and comply with the assured properties in the data sheet resp. fulfill decorative properties in accordance with IPC-A-610 "Class 2". Further claims on the products can be evaluated on request.
Notes	<ul style="list-style-type: none"> • Additional colours on request • Rated current related to rated cross-section & min. No. of poles. • P on drawing = pitch • Conductors suitable for connection: 1.5 mm² with wire-end ferrule with plastic collar, DIN 46 228/1, with a rated voltage of 125V/2.5 kV with III/3 or 250 V/2.5 kV with II/2 • Crimp shape A for wire-end ferrules with crimping tools PZ 1,5 (order no. 9005990000) or PZ 6/5 (order no. 9011460000) for larger wire cross-sections recommended. • Wire end ferrule without plastic collar to DIN 46228/1 • Wire end ferrule with plastic collar to DIN 46228/4 • Rated data refer only to the component itself. Clearance and creepage distances to other components are to be designed in accordance with the relevant application standards. • The test point can only be used as potential-pickup point. • Long term storage of the product with average temperature of 50 °C and average humidity 70%, 36 months

Approvals

Approvals



ROHS	Conform
UL File Number Search	E60693

Downloads

Approval/Certificate/Document of Conformity	CB Certificate CB Testreport Declaration of the Manufacturer
Engineering Data	STEP
User Documentation	BPZL_PUSH_IN_Connectors_BCF_3_81_EN

BCF 3.81/10/180 SN OR BX

Weidmüller Interface GmbH & Co. KG
 Klingenbergstraße 26
 D-32758 Detmold
 Germany

www.weidmueller.com

Drawings

Product image

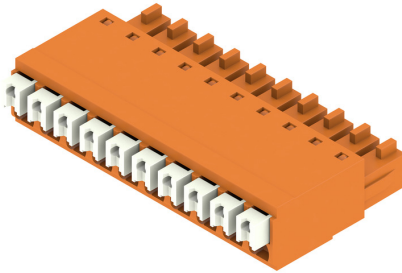

Dimensional drawing

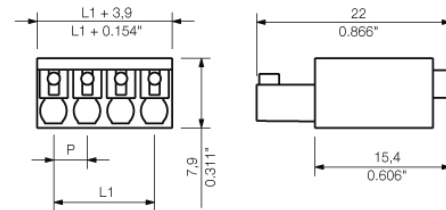

Graph

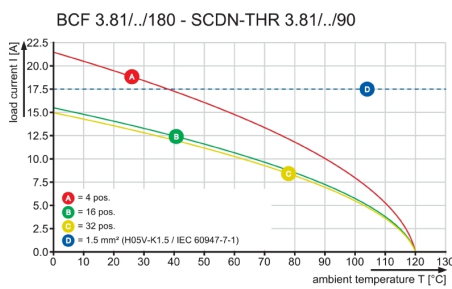

Graph

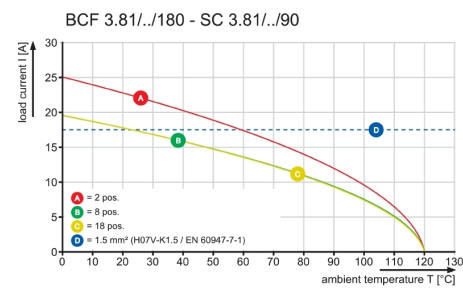

Graph

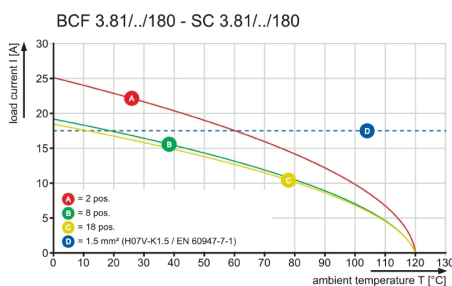

Product benefits

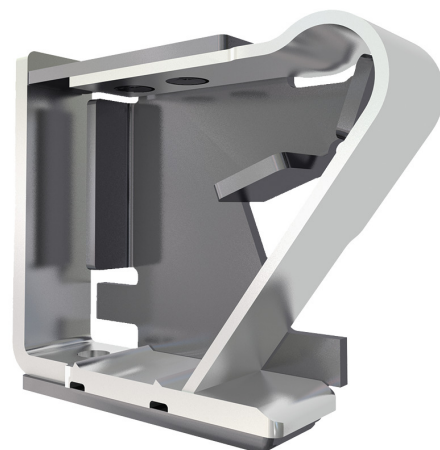

Solid PUSH IN contact
 Safe and durable

MASSE OHNE TOLERANZ SIND KEINE PRUEFMASSE
 DIMS. WITHOUT TOLERANCE ARE NOT CONTROL DIMS.

BCF 3.81/.../180 ... (2,3,4 POLE)

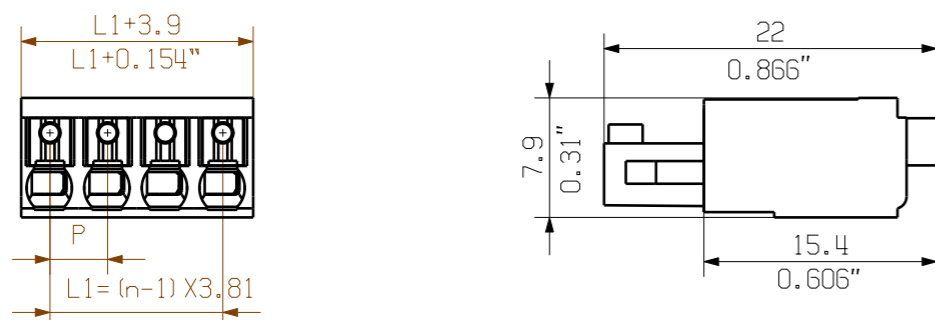

BCF 3.81/.../180LR ...

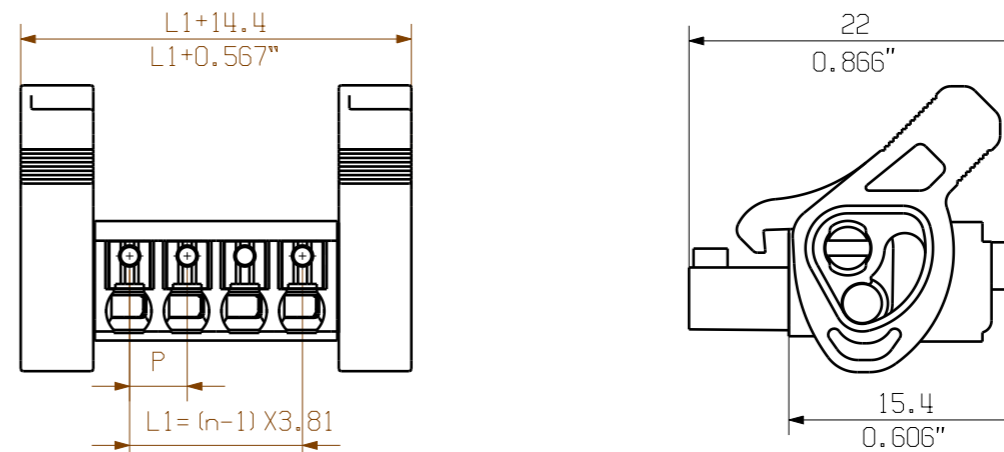

BCF 3.81/.../180 ... (5- 18 POLE)

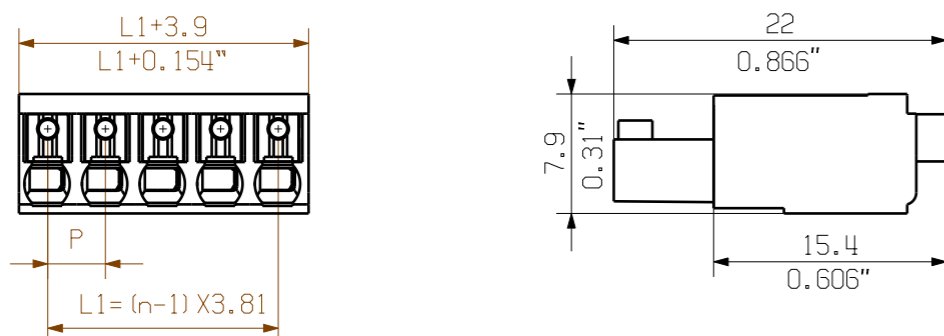

BCF 3.81/.../180F ...

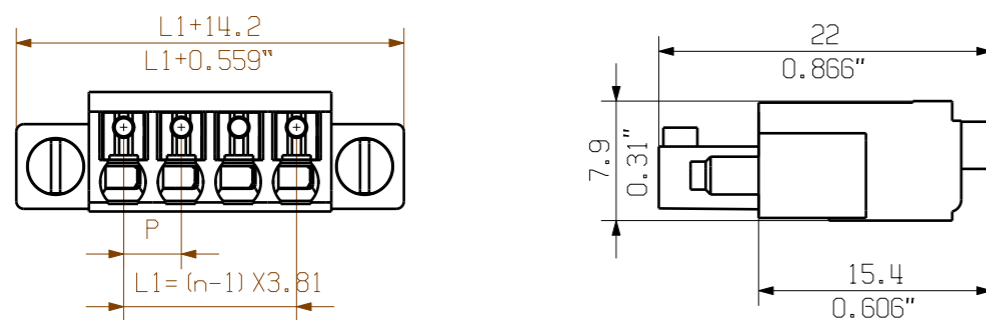

NOTE:

n=NO OF POLES
 P=PITCH

KUNDENZEICHUNG
 CUSTOMER DRAWING

18	64.77	2.550
17	60.96	2.400
16	57.15	2.250
15	53.34	2.100
14	49.53	1.950
13	45.72	1.800
12	41.91	1.650
11	38.10	1.500
10	34.29	1.350
9	30.48	1.200
8	26.67	1.050
7	22.86	0.900
6	19.05	0.750
5	15.24	0.600
4	11.43	0.450
3	7.62	0.300
2	3.81	0.150
n	L1 [mm]	L1 [inch]

For the mounting of PCBs, it should be noted that the rated data given in the catalogue relates only to the connection elements. The necessary creepage and clearance paths must be observed in connection with the respective applicant in accordance to VDE 0110. The current-carrying capacity and pitch tolerance is to be determined according to DIN IEC 326 part 3 very fine.

Weidmüller connectors are tested to the DIN VDE 0627 standard, and are valid for its field of application. Provided that the connectors are used to the intended purpose, all requirements with respect to the occurring of electrical, mechanical, thermic and corrosive stress will be satisfied.

MAX. NRN./NOS. ?		55304/5 18.05.11 GE_G 00		CAT.NO.: .	
MODIFICATION		Weidmüller		C 40414 07	
DRAWN		DATE	NAME	DRAWING NO. SHEET 01 OF 08 SHEETS	
RESPONSIBLE		27.12.2006	XU_S	ISSUE NO.	
CHECKED		03.06.2011	ZHOU_N	BCF 3.81/.../180... SN	
APPROVED			XU_S	BUCHSENLEISTE SOCKET BLOCK	
SCALE: 2/1		PRODUCT FILE: BCF 3.81		7072	
SUPERSEDES: .					

WEITERGABE SOWIE VERVIELFÄLTIGUNG DIESES DOKUMENTS, VERWERTUNG UND MITTEILUNG SEINES INHALTS SIND VERBOTEN, SOWEIT NICHT AUSDRUECKLICH GESTATTET.
 ZUWIDERHANDLUNGEN VERPFLICHTEN ZU SCHADENERSATZ. ALLE RECHTE FUER DEN FALL DER PATENT-, GEBRAUCHSMUSTER-, ODER GESCHMACKSMUSTEREINTRAGUNG VORBEHALTEN.
 THE REPRODUCTION, DISTRIBUTION AND UTILIZATION OF THIS DOCUMENT AS WELL AS THE COMMUNICATION OF ITS CONTENTS TO OTHERS WITHOUT EXPLICIT AUTHORIZATION IS PROHIBITED.
 OFFENDERS WILL BE HELD LIABLE FOR THE PAYMENT OF DAMAGES. WEIDMUELLER EXCLUSIVELY RESERVES THE RIGHT TO FILE FOR PATENTS, UTILITY MODELS OR DESIGNS.
 WEIDMUELLER INTERFACE GmbH & Co.KG