

SAID-M8B-4-SMT**Weidmüller Interface GmbH & Co. KG**

Klingenbergstraße 26

D-32758 Detmold

Germany

www.weidmueller.com

Similar to illustration

Weidmüller is one of the industry's leading international providers of connectors. An important mainstay in this product family are the circular connectors, which Weidmüller groups under the product name SAI. In the development of SAI products, Weidmüller engineers have always concentrated on achieving rational, cost-effective installation concepts, and – in cooperation with major users – have supplied the markets with well-conceived products which set standards in terms of functionality and quality across the globe. The best examples are the new power distributors with S and T coded M12. These modules are characterised by particularly high currents and voltages. This enables them to also be used, for example, with three-phase motors.

General ordering data

Version	Built-in plugs, M8, Socket connector, Number of poles: 4
Order No.	2421840000
Type	SAID-M8B-4-SMT
GTIN (EAN)	4050118429626
Qty.	25 pc(s).

Creation date March 26, 2021 10:42:13 PM CET

Catalogue status 12.03.2021 / We reserve the right to make technical changes.

SAID-M8B-4-SMT**Weidmüller Interface GmbH & Co. KG**

Klingenbergstraße 26

D-32758 Detmold

Germany

www.weidmueller.com

Technical data**Dimensions and weights**

Net weight 2.48 g

Environmental Product Compliance

REACH SVHC Lead 7439-92-1

Technical data of PCB plug-in connector

Coding	M8 = none	Housings	M8 socket
Number of poles	4	Shield connection	No
Rated voltage	30 V	Rated voltage (text)	60 V (3-pole) / 30 V (4-,5- and 8-pole)
Rated current	4 A	Rated current	4 A (3-, 4- and 5-pole) / 1.5 A (8-pole)
Temperature range	-25...95 °C	Protection degree	IP67
Contact surface	Au (Gold)	Housing main material	LCP
Connection thread	M8	Tightening torque	M8: 0.5 Nm
Insulation strength	100 MΩ	Pollution severity	3 (2 within the sealed area)
Plugging cycles	≥ 100	Contact material	CuZn
Lock nut material	Nickel-plated CuZn	Material of the flange-mounted housing	Nickel-plated CuZn

General Info

Housing main material	LCP	Connection thread	M8
Contact material	CuZn	Contact surface	Au (Gold)
Protection degree	IP67	Plugging cycles	≥ 100

Material data

Contact material	CuZn	Contact surface	Au (Gold)
------------------	------	-----------------	-----------

System parameters

Insulation strength	100 MΩ	Number of poles	4
Pin series quantity	1	Plugging cycles	≥ 100
Protection degree	IP67		

Classifications

ETIM 6.0	EC000438	ETIM 7.0	EC003557
ECLASS 9.1	27-44-02-05	ECLASS 10.0	27-44-02-23
ECLASS 11.0	27-44-02-23		

Approvals

ROHS Conform

SAID-M8B-4-SMT

Weidmüller Interface GmbH & Co. KG
 Klingenbergstraße 26
 D-32758 Detmold
 Germany

www.weidmueller.com

Drawings

Dimensioned drawing

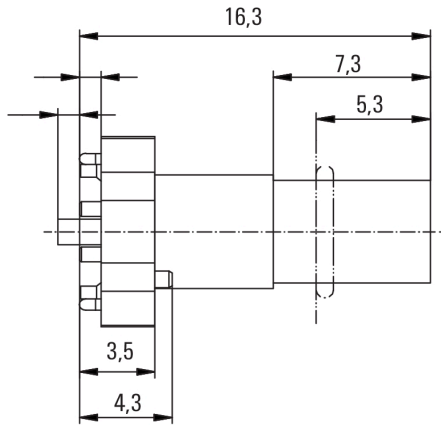

PCB design

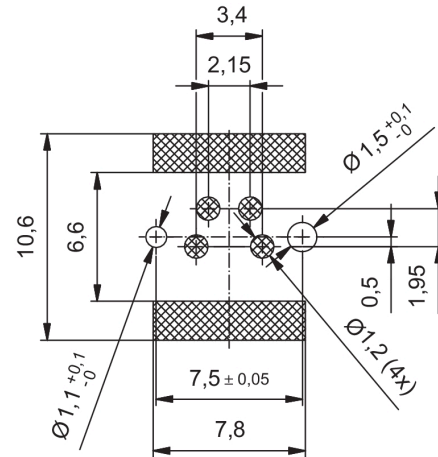

Pole scheme

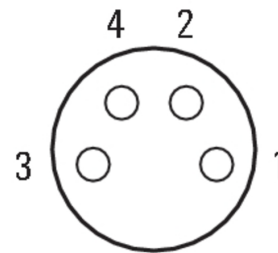

M8 = none