

**BLZF 3.50/04/180F SN BK BX**
**Weidmüller Interface GmbH & Co. KG**

Klingenbergstraße 26

D-32758 Detmold

Germany

www.weidmueller.com

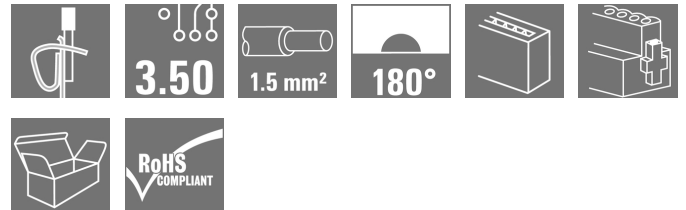
**Product image**

Female connectors with tension clamp system for connecting cables in 3.50 pitch. They provide space for labelling and can be coded.

**General ordering data**

Version	PCB plug-in connector, female plug, 3.50 mm, Number of poles: 4, 180°, Tension-clamp connection, Clamping range, max.: 1.5 mm², Box
Order No.	<a href="#">1691130000</a>
Type	BLZF 3.50/04/180F SN BK BX
GTIN (EAN)	4008190329679
Qty.	100 pc(s).
Product data	IEC: 320 V / 14.5 A / 0.2 - 1.5 mm² UL: 300 V / 10 A / AWG 26 - AWG 14
Packaging	Box

Creation date March 24, 2021 8:19:02 PM CET

**BLZF 3.50/04/180F SN BK BX****Weidmüller Interface GmbH & Co. KG**

Klingenbergstraße 26

D-32758 Detmold

Germany

www.weidmueller.com

**Technical data****Dimensions and weights**

Depth	21.9 mm	Depth (inches)	0.862 inch
Height	13 mm	Height (inches)	0.512 inch
Net weight	4.47 g	Width	21 mm
Width (inches)	0.827 inch		

**System Parameters**

Product family	OMNIMATE Signal - series BL/SL 3.50		
Type of connection	Field connection		
Wire connection method	Tension-clamp connection		
Pitch in mm (P)	3.5 mm		
Pitch in inches (P)	0.138 inch		
Conductor outlet direction	180°		
Number of poles	4		
L1 in mm	10.5 mm		
L1 in inches	0.413 inch		
Number of rows	1		
Pin series quantity	1		
Rated cross-section	1.5 mm <sup>2</sup>		
Touch-safe protection acc. to DIN VDE 57 106	Safe from finger touch		
Touch-safe protection acc. to DIN VDE 0470	IP 20		
Volume resistance	≤5 mΩ		
Can be coded	Yes		
Stripping length	10 mm		
Tightening torque for screw flange, min.	0.15 Nm		
Tightening torque for screw flange, max.	0.2 Nm		
Screwdriver blade	0.4 x 2.5		
Screwdriver blade standard	DIN 5264-A		
Plugging cycles	25		
Plugging force/pole, max.	7 N		
Pulling force/pole, max.	5 N		
Tightening torque	Torque type	Screw flange	
	Usage information	Tightening torque	min. 0.15 Nm max. 0.2 Nm

**Material data**

Insulating material	PBT	Colour	black
Colour chart (similar)	RAL 9011	Insulating material group	IIIa
Comparative Tracking Index (CTI)	≥ 200	Insulation strength	≥ 10 <sup>8</sup> Ω
UL 94 flammability rating	V-0	Contact material	Copper alloy
Contact surface	tinned	Layer structure of plug contact	4...8 μm Sn hot-dip tinned
Storage temperature, min.	-40 °C	Storage temperature, max.	70 °C
Operating temperature, min.	-50 °C	Operating temperature, max.	100 °C
Temperature range, installation, min.	-30 °C	Temperature range, installation, max.	100 °C

**Conductors suitable for connection**

Clamping range, min.	0.13 mm <sup>2</sup>
Clamping range, max.	1.5 mm <sup>2</sup>
Wire connection cross section AWG, min.	AWG 28

Creation date March 24, 2021 8:19:02 PM CET

Catalogue status 12.03.2021 / We reserve the right to make technical changes.

## BLZF 3.50/04/180F SN BK BX

**Weidmüller Interface GmbH & Co. KG**  
 Klingenbergstraße 26  
 D-32758 Detmold  
 Germany

www.weidmueller.com

## Technical data

Wire connection cross section AWG, max.	AWG 16
Solid, min. H05(07) V-U	0.2 mm <sup>2</sup>
Solid, max. H05(07) V-U	1.5 mm <sup>2</sup>
Flexible, min. H05(07) V-K	0.2 mm <sup>2</sup>
Flexible, max. H05(07) V-K	1.5 mm <sup>2</sup>
w. plastic collar ferrule, DIN 46228 pt 4, min.	0.2 mm <sup>2</sup>
w. plastic collar ferrule, DIN 46228 pt 4, max.	1 mm <sup>2</sup>
w. wire end ferrule, DIN 46228 pt 1, min.	0.2 mm <sup>2</sup>
w. wire end ferrule, DIN 46228 pt 1, max.	1.5 mm <sup>2</sup>
Outer diameter of insulation, max.	2.9 mm
Plug gauge in accordance with EN 60999 a x b; ø	2.4 mm x 1.5 mm

Clampable conductor	Cross-section for conductor connection	Type	fine-wired	
		nominal	0.5 mm <sup>2</sup>	
	wire end ferrule	Stripping length	nominal	12 mm
		Recommended wire-end ferrule	<a href="#">H0.5/16 OR</a>	
		Stripping length	nominal	10 mm
		Recommended wire-end ferrule	<a href="#">H0.5/10</a>	
	Cross-section for conductor connection	Type	fine-wired	
		nominal	0.75 mm <sup>2</sup>	
	wire end ferrule	Stripping length	nominal	12 mm
		Recommended wire-end ferrule	<a href="#">H0.75/16 W</a>	
		Stripping length	nominal	10 mm
		Recommended wire-end ferrule	<a href="#">H0.75/10</a>	
Cross-section for conductor connection	Type	fine-wired		
	nominal	1 mm <sup>2</sup>		
wire end ferrule	Stripping length	nominal	12 mm	
	Recommended wire-end ferrule	<a href="#">H1.0/16D R</a>		
	Stripping length	nominal	10 mm	
	Recommended wire-end ferrule	<a href="#">H1.0/10</a>		
Cross-section for conductor connection	Type	fine-wired		
	nominal	1.5 mm <sup>2</sup>		
wire end ferrule	Stripping length	nominal	10 mm	
	Recommended wire-end ferrule	<a href="#">H1.5/10</a>		

Reference text The outside diameter of the plastic collar should not be larger than the pitch (P), Length of ferrules is to be chosen depending on the product and the rated voltage.

## BLZF 3.50/04/180F SN BK BX

**Weidmüller Interface GmbH & Co. KG**  
 Klingenbergstraße 26  
 D-32758 Detmold  
 Germany

www.weidmueller.com

## Technical data

### Rated data acc. to IEC

tested acc. to standard	IEC 60664-1, IEC 61984	Rated current, min. number of poles (Tu=20°C)	14.5 A
Rated current, max. number of poles (Tu=20°C)	10 A	Rated current, min. number of poles (Tu=40°C)	12 A
Rated current, max. number of poles (Tu=40°C)	8 A	Rated voltage for surge voltage class / pollution degree II/2	320 V
Rated voltage for surge voltage class / pollution degree III/2	160 V	Rated voltage for surge voltage class / pollution degree III/3	160 V
Rated impulse voltage for surge voltage class/ pollution degree II/2	2.5 kV	Rated impulse voltage for surge voltage class/ pollution degree III/2	2.5 kV
Rated impulse voltage for surge voltage class/ contamination degree III/3	2.5 kV	Short-time withstand current resistance	3 x 1s with 100 A

### Rated data acc. to CSA

Institute (CSA)		Certificate No. (CSA)	200039-1461395
Rated voltage (Use group B / CSA)	300 V	Rated voltage (Use group D / CSA)	300 V
Rated current (Use group B / CSA)	10 A	Rated current (Use group D / CSA)	10 A
Wire cross-section, AWG, min.	AWG 26	Wire cross-section, AWG, max.	AWG 14
Reference to approval values	Specifications are maximum values, details - see approval certificate.		

### Rated data acc. to UL 1059

Institute (UR)		Certificate No. (UR)	E60693
Rated voltage (Use group B / UL 1059)	300 V	Rated voltage (Use group D / UL 1059)	300 V
Rated current (Use group B / UL 1059)	10 A	Rated current (Use group D / UL 1059)	10 A
Wire cross-section, AWG, min.	AWG 26	Wire cross-section, AWG, max.	AWG 14
Reference to approval values	Specifications are maximum values, details - see approval certificate.		

### Packing

Packaging	Box	VPE length	67 mm
VPE width	88 mm	VPE height	143 mm

### Type tests

Test: Durability of markings	Standard	DIN EN 61984 section 7.3.2 / 09.02 taking pattern from DIN EN 60068-2-70 / 07.96
	Test	mark of origin, type identification, rated voltage, rated cross-section, pitch, type of material, approval marking SEV, approval marking CSA
	Evaluation	available
	Test	approval marking UL
	Evaluation	on packaging label
	Test	durability
	Evaluation	passed

Creation date March 24, 2021 8:19:02 PM CET

**BLZF 3.50/04/180F SN BK BX**

**Weidmüller Interface GmbH & Co. KG**  
 Klingenbergstraße 26  
 D-32758 Detmold  
 Germany

www.weidmueller.com

**Technical data**

Test: Clampable cross section	Standard	DIN EN 60999-1 section 7 and 9.1 / 12.00, DIN EN 60947-1 section 8.2.4.5.1 / 12.99	
	Conductor type	Type of conductor and conductor cross-section	solid 0.2 mm <sup>2</sup>
		Type of conductor and conductor cross-section	stranded 0.5 mm <sup>2</sup>
		Type of conductor and conductor cross-section	solid 1.5 mm <sup>2</sup>
		Type of conductor and conductor cross-section	stranded 1.5 mm <sup>2</sup>
		Type of conductor and conductor cross-section	AWG 28/1
		Type of conductor and conductor cross-section	AWG 28/19
		Type of conductor and conductor cross-section	AWG 16/1
		Type of conductor and conductor cross-section	AWG 16/19
Evaluation	passed		
Test for damage to and accidental loosening of conductors	Standard	DIN EN 60999-1 section 9.4 / 12.00	
	Requirement	0.2 kg	
	Conductor type	Type of conductor and conductor cross-section	solid 0.2 mm <sup>2</sup>
		Type of conductor and conductor cross-section	AWG 28/1
		Type of conductor and conductor cross-section	AWG 28/19
	Evaluation	passed	
	Requirement	0.3 kg	
	Conductor type	Type of conductor and conductor cross-section	stranded 0.5 mm <sup>2</sup>
	Evaluation	passed	
	Requirement	0.4 kg	
Conductor type	Type of conductor and conductor cross-section	solid 1.5 mm <sup>2</sup>	
	Type of conductor and conductor cross-section	stranded 1.5 mm <sup>2</sup>	
	Type of conductor and conductor cross-section	AWG 16/1	
	Type of conductor and conductor cross-section	AWG 16/19	
Evaluation	passed		

**BLZF 3.50/04/180F SN BK BX**

**Weidmüller Interface GmbH & Co. KG**  
 Klingenbergstraße 26  
 D-32758 Detmold  
 Germany

www.weidmueller.com

**Technical data**

Pull-out test	Standard	DIN EN 60999-1 section 9.5 / 12.00		
	Requirement	≥5 N		
	Conductor type	Type of conductor and conductor cross-section	AWG 28/1	
		Type of conductor and conductor cross-section	AWG 28/19	
	Evaluation	passed		
	Requirement	≥10 N		
	Conductor type	Type of conductor and conductor cross-section	H05V-U0.2	
		Evaluation	passed	
	Requirement	≥20 N		
	Conductor type	Type of conductor and conductor cross-section	H05V-U0.5	
		Evaluation	passed	
	Requirement	≥40 N		
	Conductor type	Type of conductor and conductor cross-section	H05V-U1.5	
		Type of conductor and conductor cross-section	H05V-K1.5	
		Type of conductor and conductor cross-section	AWG 16/1	
		Type of conductor and conductor cross-section	AWG 16/19	
Evaluation	passed			

**Classifications**

ETIM 6.0	EC002638	ETIM 7.0	EC002638
ECLASS 9.0	27-44-03-09	ECLASS 9.1	27-44-03-09
ECLASS 10.0	27-44-03-09	ECLASS 11.0	27-46-02-02

**BLZF 3.50/04/180F SN BK BX**

**Weidmüller Interface GmbH & Co. KG**  
 Klingenbergstraße 26  
 D-32758 Detmold  
 Germany

www.weidmueller.com

**Technical data**
**Important note**

IPC conformity	Conformity: The products are developed, manufactured and delivered according international recognized standards and norms and comply with the assured properties in the data sheet resp. fulfill decorative properties in accordance with IPC-A-610 "Class 2". Further claims on the products can be evaluated on request.
Notes	<ul style="list-style-type: none"> <li>• Additional colours on request</li> <li>• Gold-plated contact surfaces on request</li> <li>• Rated current related to rated cross-section &amp; min. No. of poles.</li> <li>• Max. outer diameter of the conductor: 2.9 mm</li> <li>• Wire end ferrule without plastic collar to DIN 46228/1</li> <li>• Wire end ferrule with plastic collar to DIN 46228/4</li> <li>• Crimp shape A for wire-end ferrules with crimping tools PZ 1,5 (order no. 9005990000) or PZ 6/5 (order no. 9011460000) for larger wire cross-sections recommended.</li> <li>• P on drawing = pitch</li> <li>• Rated data refer only to the component itself. Clearance and creepage distances to other components are to be designed in accordance with the relevant application standards.</li> <li>• Long term storage of the product with average temperature of 50 °C and average humidity 70%, 36 months</li> </ul>

**Approvals**

Approvals



ROHS	Conform
UL File Number Search	E60693

**Downloads**

Approval/Certificate/Document of Conformity	<a href="#">Declaration of the Manufacturer</a>
Engineering Data	<a href="#">STEP</a>

**BLZF 3.50/04/180F SN BK BX**

**Weidmüller Interface GmbH & Co. KG**  
 Klingenbergstraße 26  
 D-32758 Detmold  
 Germany

www.weidmueller.com

Drawings

Product image

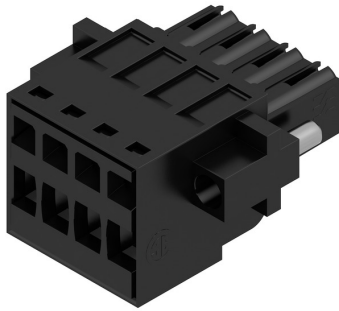

Dimensional drawing

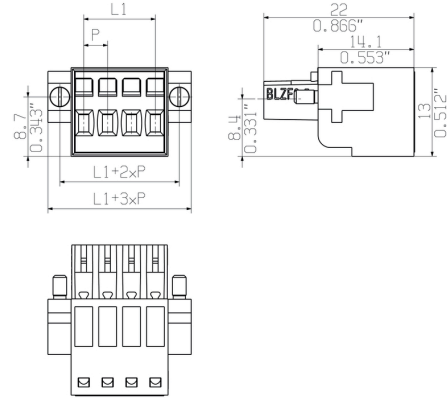

Graph

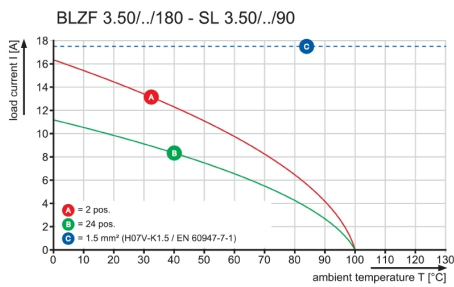

Graph



Graph



SHOWN:BLZF 3.50/04/180



SHOWN:BLZF 3.50/04/180F



SHOWN:BLZF 3.50/04/180/SO



SHOWN:BLZF 3.50/04/180LR REDESIGN



SHOWN:BLZF 3.50/04/180LR

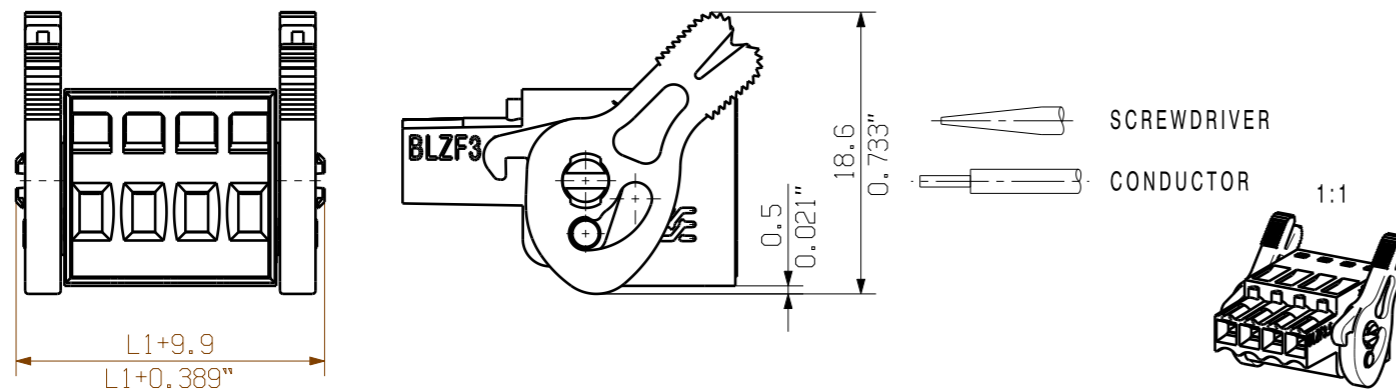

SHOWN:BLZF 3.50/04/180LH



ALLGEMEINGUELTIGE KUNDENZEICHNUNG, AKTUELLER STAND NUR AUF ANFRAGE  
GENERAL CUSTOMER DRAWING, TOPICAL VERSION ONLY IF REQUIRED

For the mounting of PCBs, it should be noted that the rated data given in the catalogue relates only to the connection elements. The necessary creepage and clearance paths must be observed in connection with the respective applicant in accordance with VDE 0110. The current-carrying capacity and pitch tolerance is to be determined according to DIN IEC 326 part 3 very fine.

Weidmüller connectors are tested to the DIN VDE 0627 standard, and are valid for its field of application. Provided that the connectors are used to the intended purpose, all requirements with respect to the occurring of electrical, mechanical, thermic and corrosive stress will be satisfied.

POLZAHL POLES	L1 (mm)	L1 (inch)
24	80.5	3.169
23	77.0	3.032
22	73.5	2.894
21	70.0	2.756
20	66.5	2.618
19	63.0	2.480
18	59.5	2.343
17	56.0	2.205
16	52.5	2.067
15	49.0	1.929
14	45.5	1.791
13	42.0	1.654
12	38.5	1.516
11	35.0	1.378
10	31.5	1.240
9	28.0	1.102
8	24.5	0.965
7	21.0	0.827
6	17.5	0.689
5	14.0	0.551
4	10.5	0.413
3	7.0	0.276
2	3.5	0.138

	DIN ISO 2768-m	Cat.no.: .	
	93783/5 24.11.17 HELIS_MA 02		
Modification		<b>3 23142</b>	
		Drawing no. <b>3 23142</b> Issue no. <b>20</b> Sheet 01 of 01 sheets	
Scale: 2/1	Drawn 10.12.2007 HELIS_MA Responsible AMANN_A Checked 08.01.2018 HELIS_MA Supersedes: .	<b>BLZF 3.50/./180..</b> BUCHSENSTECKER FEMALE PLUG	
	Date 10.12.2007 Name HELIS_MA Approved LANG_T	Product file: BLZF 3.50 <span style="float: right;">7357</span>	

The reproduction, distribution and utilization of this document as well as the communication of its contents to others without explicit authorization is prohibited. Offenders will be held liable for the payment of damages. Weidmüller exclusively reserves the right to file for patents, utility models or designs.

